

## ► Blustream Multicast

# IP50HD-TX/RX

User Manual

**Thank you for purchasing this product**

For optimum performance and safety, please read these instructions carefully before connecting, operating or adjusting this product. Please keep this manual for future reference.

**Surge protection device recommended**

This product contains sensitive electrical components that may be damaged by electrical spikes, surges, electric shock, lightning strikes, etc. Use of surge protection systems are highly recommended in order to protect and extend the life of your equipment.

**Safety And Performance Notice**

The transmission distances of HDMI over UTP cables are measured using TE CONNECTIVITY 1427071-6.

EIA/TIA-568-B termination (T568B) of cables is recommended for optimal performance.

To minimise interference of the unshielded twisted pairs in the CAT5e/6/6a cable do not run the Cat5e/6/6a cabling with or in close parallel proximity to mains power cables.

Do not substitute or use any other power supply other than approved PoE network products or approved Blustream power supplies.

Do not disassemble any Blustream Multicast products for any reason. Doing so will void the manufacturer’s warranty.



# Contents

- Introduction \_\_\_\_\_03
- Features \_\_\_\_\_03
- Panel Description - IP50HD-TX Transmitter \_\_\_\_\_04
- Panel Description - IP50HD-RX Receiver \_\_\_\_\_05
- Unicast or Multicast \_\_\_\_\_06
- HDMI over IP Network Configuration \_\_\_\_\_06
- Configuration & Control of an IP50HD System \_\_\_\_\_06
- Understanding Product Status Lights \_\_\_\_\_07
- Audio Connections - Transmitter \_\_\_\_\_07
- Audio Connections - Receiver \_\_\_\_\_07
- InfraRed Control \_\_\_\_\_08
- Remote Control - REM100 \_\_\_\_\_08
- InfraRed Distribution \_\_\_\_\_09
- Infrared Pass-Through (Source Control) \_\_\_\_\_10
- Infrared Pass-Through (Display Control) \_\_\_\_\_11
- RS-232 (Serial) Bi-Directional Pass-Through \_\_\_\_\_12
- Manual Configuration \_\_\_\_\_13-14
- EDID Control \_\_\_\_\_15
- Scaler Output Control \_\_\_\_\_16
- IP50HD IP Addresses \_\_\_\_\_17
- IP50HD Web-GUI \_\_\_\_\_18-22
- Configuring a Computer IP address \_\_\_\_\_23-25
- Schematic \_\_\_\_\_26
- Specifications \_\_\_\_\_27
- Package Contents \_\_\_\_\_27
- Certifications \_\_\_\_\_28

## Introduction

Our Contractor HD Multicast distribution platform allows distribution of AV and control signals over a 1Gb network. The IP50HD-TX/RX is an industry leading 1080p HDMI distribution system that uses H.265 compression technology to deliver HDMI, Bi-directional IR, RS-232 & USB/KVM up to lengths of 100m over standard network architecture. The IP50HD can be powered via PoE from the network switch or locally should the switch not support PoE. With multiple configuration options available the Multicast HD solution is ideal for both commercial and residential installations.

Furthermore the ACM200 Advanced Control Module with in-built web-GUI, pre-built 3rd party control drivers, and simplified switch configuration guides simplify Multicast product installation, and negate the need for an understanding of complex network infrastructures.

---

## Features

- Advanced HD video, control and KVM over network infrastructure
- Extends HDMI up to a distance of 100m over a single CAT cable
- Supports unicast transmission over unmanaged networks
- Supports multicast transmission for large managed networks
- Supports up to 1080p 60Hz max
- In-built video scaler on Receiver to allow for inclusion of displays with differing resolution capabilities
- Transmitter features 1 x HDMI loop-out for integrating local displays or cascading to multiple devices
- Supports PCM 2.0 channel audio only
- Advanced signal management for independent routing of IR, RS-232, USB/KVM, and video/audio
- Analogue L/R audio embedding on Transmitter and audio breakout on both Transmitter and Receiver
- HDCP 1.4 compliant with advanced EDID management
- PoE (Power over Ethernet) to power Blustream products from a PoE switch
- Local 12V 1A power supply should Ethernet switch not support PoE (not included)
- Features 2 operational modes:
  - - Matrix distribution (requires 1Gb network switch)
  - - One-to-one HDMI extender (no network switch required)
- Simple configuration via web-GUI through the ACM200
- RS-232, IR and Telnet/IP integration for control of Multicast system using the Blustream ACM200
- 3rd party drivers available for major control brands

### Please note:

The Blustream Multicast system distributes HDMI video over Layer 3 Managed network hardware. It is advised that Blustream Multicast products are connected to an independent network switch to prevent interference or drop in signal performance due to other network products demands.

Please take care to make sure that the instructions contained within this manual have been read and understood, and that the network switch has been correctly configured prior to connecting any Blustream Multicast products. Failure to do so will result in problems with configuration of the system and video performance.

# Panel Description - IP50HD-TX Transmitter

## IP50HD-TX Front Panel

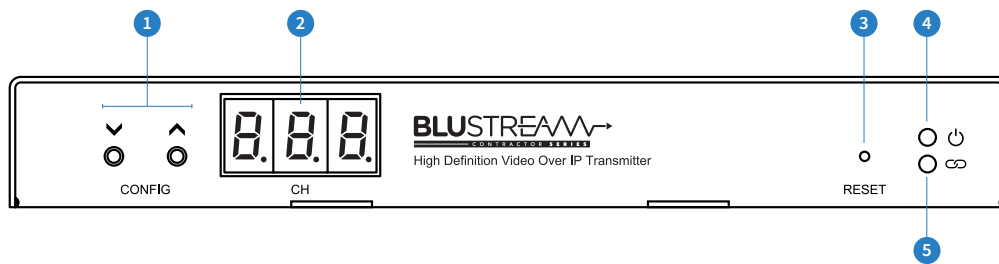

## IP50HD-TX Rear Panel

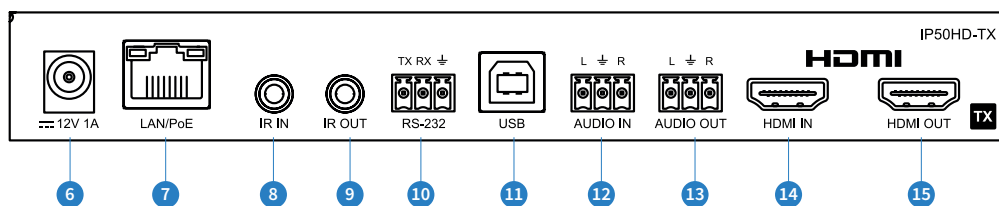

- 1 Config Up/Down - configure IP50HD-TX manually
- 2 Channel status window - displays product information
- 3 Reset button - short press to restart / reboot device, press and hold for 10 seconds to factory reset device
- 4 Power LED indicator
- 5 Link LED indicator - solid status light indicates a stable connection to the network switch
- 6 Power port – use 12V 1A DC adaptor (sold separately) if not using a PoE network switch
- 7 LAN Connection (PoE) - connect to network switch for HDMI video distribution
- 8 IR IN (IR input) – 3.5mm stereo jack. Transmits IR to any IP50HD-RX receiver currently viewing the IP50HD-TX. Supports 5V or 12V IR selectable in product web-GUI or ACM200 web-GUI
- 9 IR OUT - (IR output) - 3.5mm mono jack – routed IR from any IP50HD-RX (zone output) allowing source control. Supports 5V or 12V IR selectable in product web-GUI or ACM200 web-GUI
- 10 Assignable bi-directional RS-232 port – connect to third party control device to extend RS-232 commands to any/multiple IP50HD Multicast products RS-232 port
- 11 USB host connection for USB/KVM routing within Multicast system
- 12 L/R Analogue audio line input - embed analogue audio onto HDMI signal
- 13 L/R Analogue audio line output - 2ch audio that supports 2ch PCM source inputs
- 14 HDMI input – connect to a HDMI source
- 15 HDMI output - loop out of HDMI input source

# Panel Description - IP50HD-RX Receiver

## IP50HD-RX Front Panel



## IP50HD-RX Rear Panel

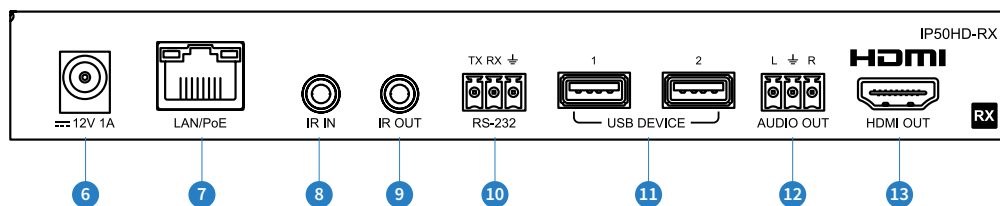

- 1 Channel Select Up/Down - configure IP50HD-RX manually and select channel of TX to view
- 2 Channel status window - displays product information
- 3 Reset button - short press to restart / reboot device, press and hold for 10 seconds to factory reset device
- 4 Power LED indicator
- 5 Link LED indicator - solid status light indicates a stable connection to the network switch
- 6 Power port – use 12V 1A DC adaptor (sold separately) if not using a PoE network switch
- 7 LAN Connection (PoE) - connect to network switch for HDMI video distribution
- 8 IR IN (IR input) – 3.5mm stereo jack. Transmits IR to the IP50HD-TX transmitter currently selected. Supports 5V or 12V IR selectable in product web-GUI or ACM200 web-GUI
- 9 IR OUT - (IR output) - 3.5mm mono jack – routed IR from any IP50HD-TX (source) allowing display control. Supports 5V or 12V IR selectable in product web-GUI or ACM200 web-GUI
- 10 Assignable bi-directional RS-232 port – connect to third party control device to extend RS-232 commands to any/multiple IP50HD Multicast products RS-232 port
- 11 USB device connection for USB/KVM routing within Multicast system
- 12 L/R Analogue audio line output - 2ch audio that supports 2ch PCM source inputs
- 14 HDMI output - connect to display device

## Unicast or Multicast

The Blustream IP50HD system supports both unicast and multicast video transmission.

A unicast transmission sends the video stream from a transmitter to a single receiver on a network. Note that for each receiver that connects to the transmitter, you are duplicating the bandwidth being transmitted. The IP50HD features a 100Mbps connection and each transmission is up to 20Mbps in bandwidth, due to this the number of devices a transmitter can send to in unicast mode is limited. Unicast can only be utilised in smaller systems where network infrastructure may not support multicast functionality. The recommended max number of streams is as follows:

ENCODING BANDWIDTH	# OF UNICAST STREAMS FROM TRANSMITTER
20Mbps	3 Receivers
16Mbps	4 Receivers
8Mbps	8 Receivers
4Mbps	16 Receivers
1Mbps	64 Receivers

A multicast transmission sends the video stream to multiple receivers on a network. The network infrastructure handles the distribution of the video stream to any number of receivers using multicast functionality, without requiring additional bandwidth. Due to this, a multicast system can be utilised for larger systems where network infrastructure supports multicast. This is the default configuration, and highly recommended mode of operation.

## HDMI over IP Network Configuration

The Blustream Multicast system distributes HDMI video over Layer 3 Managed network hardware. It is advised that Blustream Multicast products are connected to an independent network switch to prevent interference or drop in signal performance due to other network products bandwidth requirements.

Blustream Multicast products are not limited to certain brands of network hardware, but should a network switch that Blustream have not tested or written instructions for be used, ensure it supports the following network features:

**Multicast** - (one-to-many or many-to-many distribution) is group communication where information is addressed to a group of network devices simultaneously (Blustream IP50HD-RX Receivers).

**Instant Leave / Fast Leave / Immediate Leave** - a feature associated with Multicast and means that as soon as an active connection is no longer required (the link between Transmitter and Receiver) the Multicast group and flow of track is stopped instantly. This prevents unnecessary flow of network traffic on the network switch.

**IGMP Snooping** - the process of listening to Internet Group Management Protocol (IGMP) network traffic. The feature allows a network switch to listen in on the IGMP conversation between hosts and routers (Transmitters and Receivers). By listening to this flow of traffic the switch maintains a map of which links need which IP multicast streams. Multicasts may be filtered from the links which do not need them and thus controls which ports receive specific multicast traffic.

**Please note:** Blustream have worked with many network switch providers to create setup guides and saved configuration files to help configure the products to work with Multicast hardware. These configuration files can be downloaded from the Blustream website, by selecting the "LAN Switch Guides" button on any Multicast product page.

## Configuration & Control of an IP50HD Multicast System

**Blustream recommend the use of an ACM200 for configuration and control of the IP50HD Multicast system.**

The Blustream ACM200 includes a web interface module for simple configuration and control of a Multicast system. The web-GUI features 'drag and drop' source selection with video preview, control of independent routing of IR, RS-232, USB/KVM, and Audio/Video. Pre-built Blustream product drivers simplify Multicast product installation and negate the need for an understanding of complex network infrastructures. We recommend every IP50HD Multicast system utilises an ACM200. Please see the ACM200 User Manual for further information. 

## Understanding Product Status Lights

IP50HD products have several LED lights to indicate connectivity status, or to help diagnose connection problems.



### IP50HD Status Lights

- 1 LAN PoE status light - solid Orange indicates PoE from the network switch powering the Multicast product
- 2 LAN status light - solid Green indicates active network connection
- 3 Power status light - Off = No power, Flashing = Product booting, On = Power on / booted
- 4 Link status light - Off = No connection to network, Flashing = not connected to any device (another Multicast product or network switch), On = Connected to Multicast device or network switch

## Audio Connections - TX Audio Embedding / De-embedding

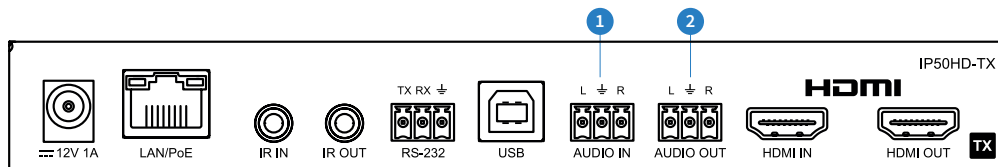

- 1 Audio In - Analogue L/R Line Level audio input (3-pin Phoenix)  
 The analogue line level input can be used to replace the original HDMI audio of the source connected to the Multicast Transmitter with analogue L/R 2ch line level audio. The embedded analogue audio is then distributed with the adjacent HDMI video signal throughout the Multicast system.  
 Switching between original HDMI audio and embedded line level analogue 2ch audio is achieved using Blustream serial/Telnet/IP commands, or by selecting the Audio Source within the ACM200 web-GUI.  
**Please note:** It is only possible to select either HDMI audio or local analogue line input. It is not possible to distribute both audio sources simultaneously.
- 2 Audio Out - Analogue L/R Line Level audio output (3-pin Phoenix)  
 The analogue line level output can be used to breakout the embedded 2ch analogue source audio from the HDMI input signal.

## Audio Connections - RX Audio Breakout

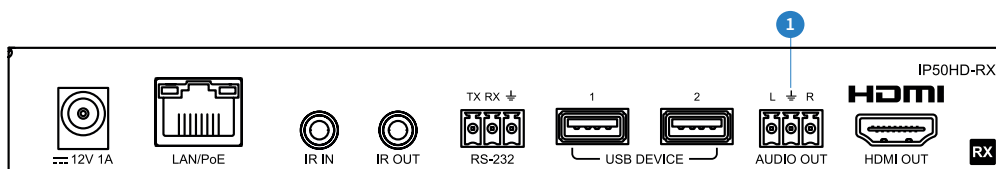

- 1 Analogue L/R Line Level audio output (3-pin Phoenix)  
 The IP50HD-RX Multicast Receiver includes audio breakout from the selected HDMI source to associated Analogue L/R audio outputs. Extracted audio will be concurrent with the corresponding HDMI video output.

**Please note:** The source input must be PCM 2ch audio for the analogue audio output to work. The Blustream Multicast products do not support multichannel audio signals.

# InfraRed Control

The Blustream Multicast system can be controlled using local IR hardware connected directly to the IP50HD-RX Receiver. This prevents the need for a third party control solution. Only the source selection feature is available using local IR control through the Receiver. For advanced features such as audio embedding etc, RS-232 or TCP/IP control will need to be used.

Blustream have created 80x IR commands allowing source selection of up to 80x IP50HD-TX Transmitters. For systems larger than 80x source devices (IP50HD-TX) the ACM200 control module is recommended.

For the complete database of Multicast IR commands, please visit the Blustream website page for any Multicast product, click on the "Drivers & Protocols" button, and navigate to the folder named "Multicast IR Control".

## Infrared Control of IP50HD-RX using REM100 (sold separately):

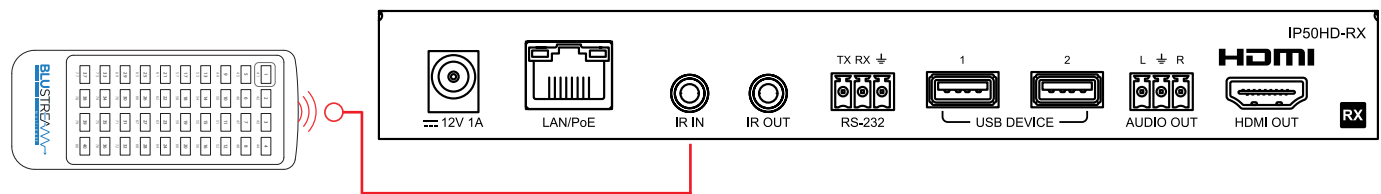

## Infrared Control using Third Party Control System and ACM200

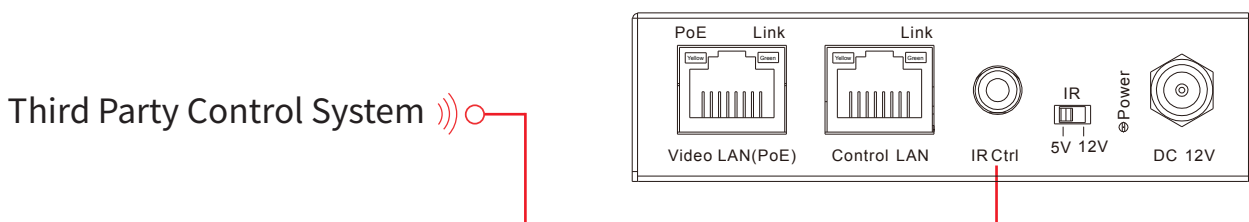

# Remote Control - REM100

## Input (Transmitter) Selection

The Blustream REM100 remote control can be used at any Blustream Multicast RX Receiver product and can select up to 80x source inputs (Transmitters).

### Using the remote:

Sources 1-40 are selected using the input selection buttons 1-40.

Sources 41-80 are selected by first activating the 'secondary control mode' which is achieved by pressing and holding source button 1 (top left) for 5 seconds. Once this mode is active the buttons 1-40 are now selecting sources 41-80.

To return control back to source inputs 1-40 simply press and hold source button 1 for 5 seconds to revert to 'main control mode'.

## Controlling the ACM200 via IR

The ACM200 can be controlled via IR using the Blustream REM88 or REM16 remote control (up to 16x16), not the REM100. This functions the same as Blustream matrix products, by first selecting the output you wish to control and then selecting the corresponding source input to switch to.

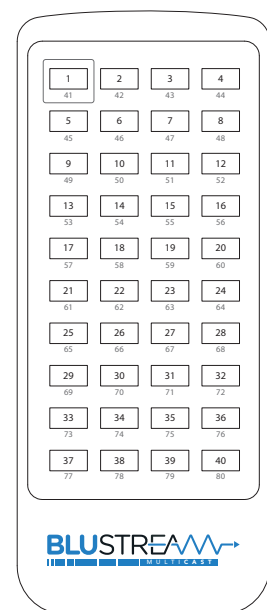



## InfraRed Distribution

The Blustream range of Multicast products include multiple options for control and routing of IR.

**IMPORTANT: Blustream InfraRed products are all 5V and NOT compatible with alternative manufacturers InfraRed solutions. When using third party 12V IR control solutions please use the Blustream IR-CAB cable for IR conversion, or ensure 12V IR is enabled in the IP50HD-TX/RX.**

Each Blustream Multicast Transmitter and Receiver is supplied with both an IR Receiver and Emitter, details below:

### IR Emitter - IRE1 & IRE2 (IRE2 sold separately)

Blustream 5V IR Emitter designed for discrete IR control of hardware

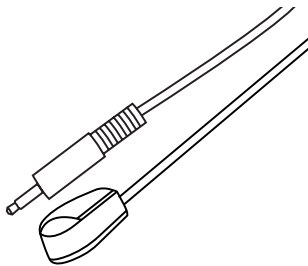

### Infrared 3.5mm Pin-Out

#### IR Emitter - Mono 3.5mm

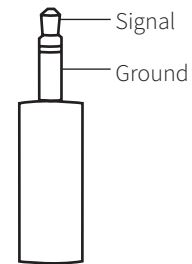

### IR Receiver - IRR

Blustream 5V IR receiver to receive IR signal and distribute through Blustream products

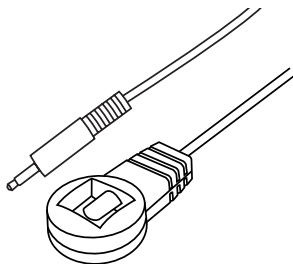

### IR Receiver - Stereo 3.5mm

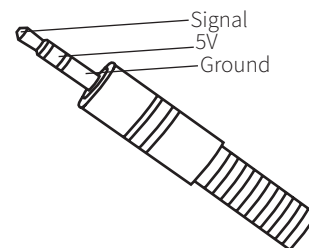

### IR Control Cable - IR-CAB (sold separately)

Blustream IR Control cable 3.5mm Mono to 3.5mm Stereo for linking third party control solutions to Blustream products.

Compatible with 12V IR third party products.

**Please note:** Cable is directional as indicated

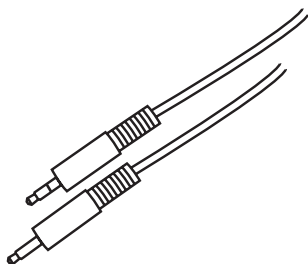

## InfraRed Pass-Through (Source Control)

The Multicast products feature InfraRed pass-through allowing users to use an original source remote to control the sources located in another area.

The IR signal is routed discretely to the source that is currently selected, meaning that individual source control can be achieved with installations consisting of multiple source equipment of the same type, i.e. - multiple satellite boxes of the same make / model.

**Please note:** The IR pass-through features are available in all modes of Multicast use (matrix mode, one-to-one, and one-to-many)

### Connections:

The IRR - IR receiver is connected to the IR IN socket on the IP50HD-RX.

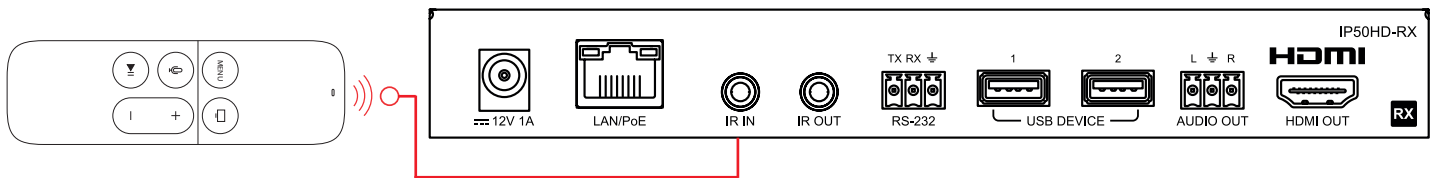

The IRE1 - IR emitter is connected to the IR OUT socket on the IP50HD-TX and the bud should be located directly on top of the IR receiver window of the source device.

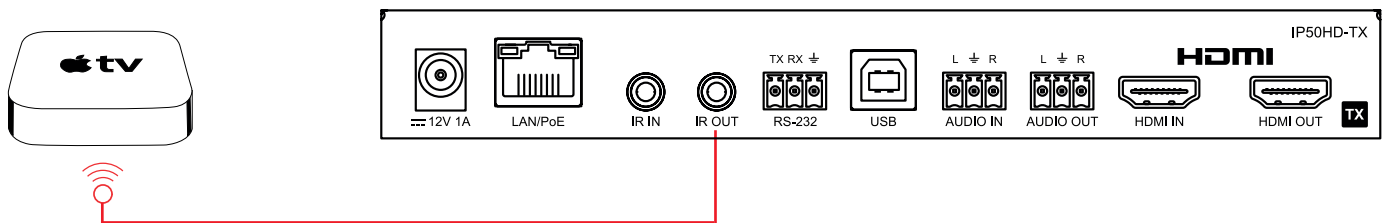

## InfraRed Pass-Through (Display Control)

Using the ACM200, IR can be routed independently from any IP50HD-TX to any IP50HD-RX unit for display control, regardless of the current video stream routing between a receiver and another transmitter.

Instructions for the configuration of Fixed Routing can be found in the ACM200 User Manual, downloadable from the Blustream website.

### Connections:

When using third party 12V IR control solutions please use Blustream IR-CAB cable for IR conversion from 12V to 5V, or ensure 12V IR is enabled in the TX and/or RX. A straight-through stereo 3.5mm cable can be used if the voltage is matched between control system and IP50HD device. Connect the IR output of the third party control system to the IR IN of the IP50HD-TX.

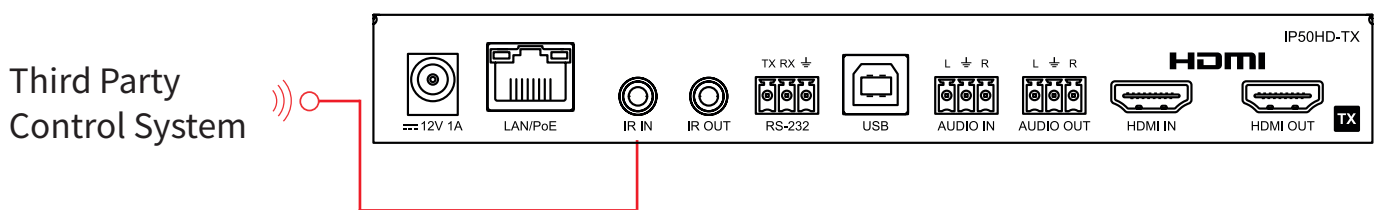

The IRE1 - IR emitter is connected to the IR OUT socket on the IP50HD-RX and the bud should be located directly on top of the IR receiver window of the display device.

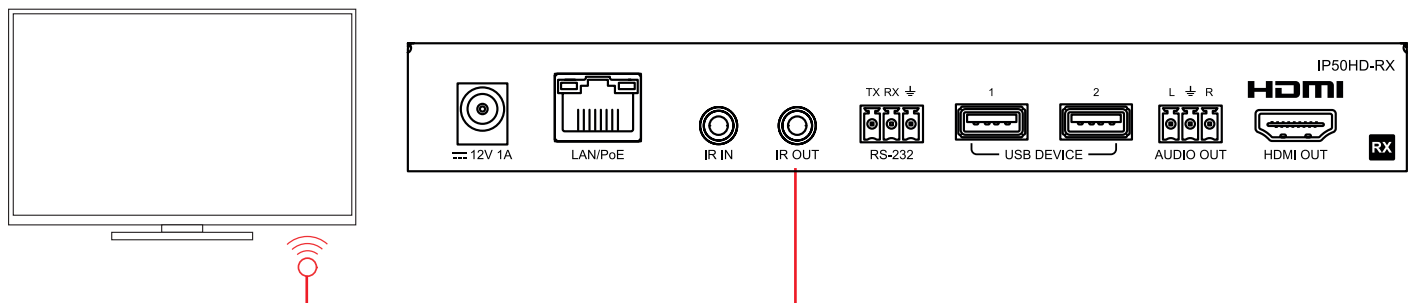

# RS-232 (Serial) Bi-Directional Pass-Through

IP50HD products feature bi-directional RS-232 pass-through for control of products using serial commands. There are multiple methods for distribution of RS-232 using the Blustream Multicast solution which include:

## 1) Fixed Routing - 1-to-1 routed RS-232

A link is programmed that creates an open connection that is fixed between any Transmitter and Receiver in the system. Once established the RS-232 commands can be sent in either direction between devices. Multiple links can be created between Multicast products for additional independent product control.

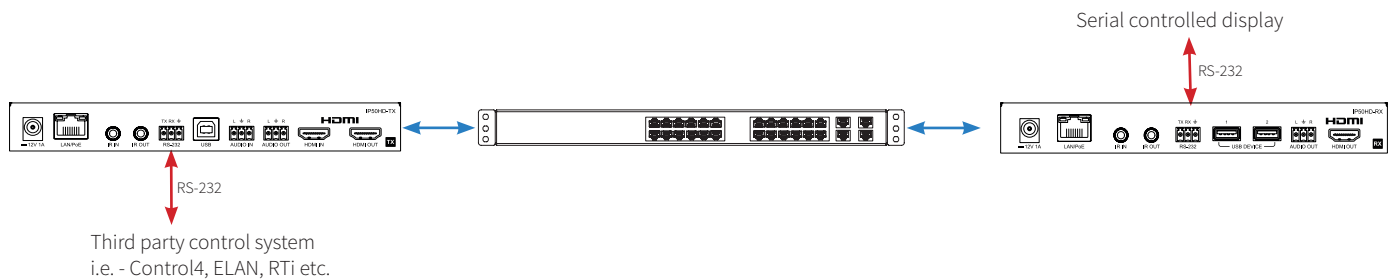

## 2) Dumb Redirect Mode - 1-to-many RS-232

A link is opened when a receiver(s) is connected to a transmitter in the system. Once established the RS-232 commands can be sent in either direction between products, allowing a single command to be sent to 1 or many receivers at the same time i.e. - All displays powered on.

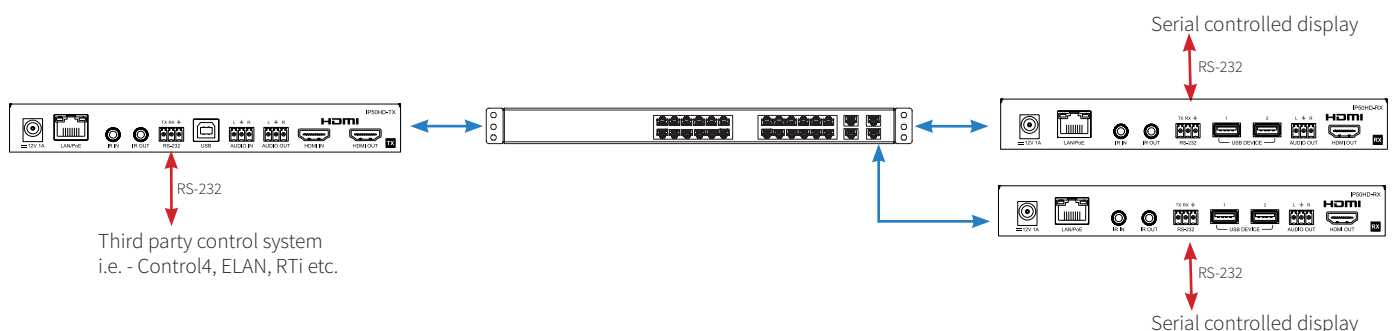

## 3) Guest Mode - Telnet/IP conversion to RS-232

This method of control converts a Telnet/IP control command into an RS-232 command. A link is programmed that creates an open connection between an ACM200 control module and any IP50HD-TX or RX (Transmitter or Receiver) product in the system. Telnet/IP commands are sent into the ACM200 from a third party control solution. This is then converted into an RS-232/serial command for control of third party products.

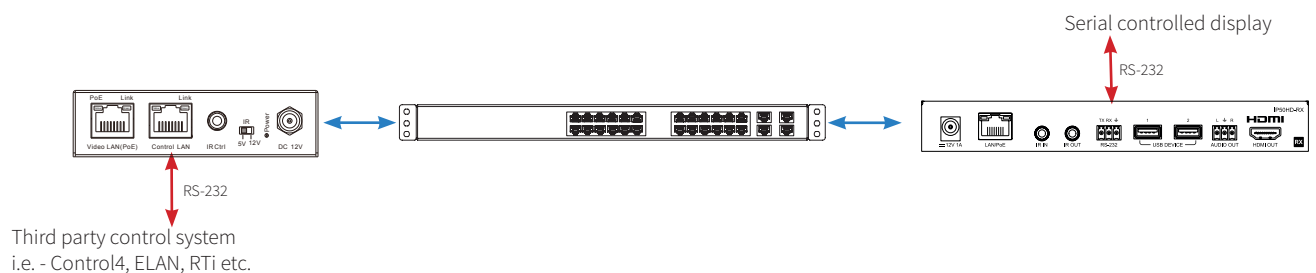

**Please note:** Only one method of RS-232 pass-through can be used at the same time. It is not possible to mix different methods of RS-232 control simultaneously.

## Manual Configuration of Multicast Products

The Blustream Multicast system can be configured without the need of a computer, allowing basic setup options such as addressing of products (IP configuration), EDID selection, and Scaler output selection.

Manual configuration does not require the product to be connected to a network switch in order to be set-up, it only requires the units to be powered either by local power supply or by a PoE switch/power injector. This means total configuration can easily be achieved offsite without any network hardware in place.

**Please note:** Advanced features such as fixed routing cannot be setup via manual configuration, and requires the ACM200 web-GUI.

### Configuring the IP50HD-TX:

**1) Power the IP50HD Transmitter** - to configure the Multicast Transmitter first connect the product to a power supply (local or PoE network) and wait for the product to boot-up. The front panel LED display will rotate whilst booting and display a 2 digit number when complete. This will be '00' if the unit has default settings.

**2) Put the IP50HD-TX into 'Local Configuration' mode** - once the product is powered press both the 'UP' and 'DOWN' Config buttons on the front panel at the same time for 10 seconds to enter 'Local Configuration' mode. The LCD front display of the product will show '**LC**' when it is in this mode.



**3) Assign the Transmitter ID (IP address)** - once the product is in Local Configuration (LC) mode the display will begin to flash with a lowercase 't' to indicate the assigning of the transmitters identity. The identity will also be the IP address that is automatically assigned, so is of utmost importance that an individual ID not equal to another TX unit in the system is assigned:

- The first ID that should be assigned is ID001 = 169.254.3.1 (IP address 1)
  - The second ID that should be assigned is ID002 = 169.254.3.2 (IP address 2)
- and so on....

Once the ID number has been selected and is correct, confirm the selection by pressing both Config 'UP' and 'DOWN' buttons at the same time to move on to setting the EDID.

**4) Set the EDID** - once the product is in EDID configuration mode the display will begin to flash with a lowercase 'e' to indicate that the assigning of an EDID value is about to commence. Use the 'UP' or 'DOWN' arrows to select the EDID setting required. A full list of EDID settings can be found in the 'EDID Control' section of this manual.

For example: if the display shows '00' the EDID will be 1080p 2ch.

Once required EDID has been selected, press both Config 'UP' and 'DOWN' buttons together to finalise the manual configuration.

The Multicast Transmitter will reboot with the new settings applied.

## Configuring the IP50HD-RX:

**1) Power the IP50HD Receiver** - to configure the Multicast Receiver first connect the product to a power supply (local or PoE network) and wait for the product to boot up. The front panel LED display will rotate whilst booting and display a 2 digit number when complete. This will be '00' if the unit has default settings.

**2) Put the IP50HD-RX into 'Local Configuration' mode** - once the product is powered press both the 'UP' and 'DOWN' Channel Select buttons on the front panel at the same time for 6 seconds to enter 'Local Configuration' mode. The LCD front display of the product will show 'LC' when it is in this mode.



**3) Assign the Receiver ID (IP address)** - once the product is in Local Configuration (LC) mode the display will begin to flash with a lowercase 'r' to indicate the receivers identity is going to be assigned. The identity will also be the IP address that is automatically assigned, so is of utmost importance that an individual ID not equal to another RX unit in the system is assigned:

- The first Receiver ID assigned is ID001 = 169.254.6.1 (IP address 1)

- The second Receiver ID is ID002 = 169.254.6.2 (IP address 2)

and so on....

Once the ID number has been selected and is correct, confirm the selection by pressing both Channel 'UP' and 'DOWN' buttons at the same time to move on to setting the scaled output.

**4) Set the Video Scaler of the Receiver** - once the product ID has been configured the display will begin to flash with an 's' to indicate that the scaler output is next to be configured. Use the 'UP' or 'DOWN' arrows to select the scaler setting required. A full list of scaler settings can be found in 'Scaler Output Control' section of this manual.

For example: if the display shows '01' the Scaler output will be 1080p 60Hz.

Once the Scaler output that is required for the display connected to the HDMI output of the RX has been set, press both Channel 'UP' and 'DOWN' buttons at the same time to move onto setting permissions.

**5) Setting Permissions** - after the scaler output has been set, the permissions of the Receiver now need to be configured. The display in the unit will start to flash with the letters 'CH'. Use the 'UP' or 'DOWN' arrows to select the maximum channel permission number required.

Maximum channel permissions allow for the Receiver to be set up so that it can / cannot access Transmitters within the system. If the system has 6x TX units and the max channel permissions of the RX is set to 05, the Receiver will have access to the first 5x transmitters (ID's 001 - 005) and not any other Transmitter after. The number set will equal the last Transmitter in the system that can be accessed.

Setting the permission value to '00' ignores the permissions and will mean that the Receiver being manually configuring can therefore access ALL transmitters in the system.

Once the permission value required has been selected, press both Channel 'UP' and 'DOWN' buttons to finalise the manual configuration.

The Multicast Receiver will then reboot with the new settings applied.

## EDID Control

EDID (Extended Display Identification Data) is a data structure that is used between a display and a source. This data is used by the source to find out what audio and video resolutions are supported by the display device. From this information the source will discover what the best audio and video resolutions need to be output.

In a normal matrix based system, issues can arise when multiple displays or video matrix switching is introduced because of the increased number of variables.

In the Blustream Multicast system each source device only communicates with a single Blustream IP50HD-TX Transmitter meaning there is only a single EDID handshake. As each Blustream Multicast IP50HD-RX Receiver has its own in-built video scaler, it is advised that the source EDID is set to output the best video signal possible as this can be down-scaled (as required) at each IP50HD-RX Receiver.

Configuration of Multicast EDID settings can be achieved in several ways:

- 1) During the manual configuration of the IP50HD-TX Transmitter - see previous pages
- 2) Using the Multicast Web-GUI interface (by addressing the unit via it's IP Address within a browser)
- 3) Using the Web-GUI of the Blustream ACM200
- 4) Using RS-232 commands via the Blustream ACM200

When configuring the EDID during manual setup, or using RS-232 commands the following table indicates EDID values:

EDID	MULTICAST TRANSMITTER EDID SETTINGS
00	Default EDID (Pass-through)
01	HDMI 1080p@60Hz, Audio 2CH PCM
02	HDMI 1280x720 @60Hz, Audio 2CH PCM
03	DVI 1280x720 @60Hz, No Audio
04	DVI 1920x1080 @60Hz, No Audio
05	DVI 1920x1200 @60Hz, No Audio
06	HDMI 1920x1200 @60Hz, Audio 2CH PCM
07	User EDID 1
08	User EDID 2

**Please note:** The Blustream IP50HD products only support 2ch audio signals. The available EDID options therefore only allow for 2ch audio formats.

## Scaler Output Control

The Blustream Multicast Receiver has an in-built video scaler which can both up-scale and downscale video signals allowing for differing image resolutions at each display.

Configuration of Multicast Scaler settings can be achieved in several ways:

- 1) During the manual configuration of the IP50HD-RX Receiver - see previous pages
- 2) Using the Multicast web-GUI interface (by addressing the unit via it's IP Address within a browser)
- 3) Using the Web-GUI of the Blustream ACM200
- 4) Using RS-232 commands via the Blustream ACM200

When configuring the Scaled output during manual setup, or using RS-232 commands, the following table indicates Scaler settings.

SCALER	MULTICAST RECEIVER SCALER SETTINGS
00	Pass Through - allows native source resolution to pass-through to display * (default setting)
01	HDMI 1080p@60Hz
02	HDMI 1080p@50Hz
03	HDMI 1080p@30Hz
04	HDMI 1080p@25Hz
05	HDMI 1080p@24Hz
06	HDMI 720p@60Hz
07	HDMI 720p@50Hz
08	HDMI 576p@50Hz
09	HDMI 480p@60Hz
10	HDMI 640x480@60Hz
11	HDMI 800x600@60Hz
12	HDMI 1024x768@60Hz
13	HDMI 1280x800@60Hz
14	HDMI 1280x1024@60Hz
15	HDMI 1366x768@60Hz
16	HDMI 1440x900@60Hz
17	HDMI 1600x1200@60Hz
18	HDMI 1600x1050@60Hz
19	HDMI 1900x1200@60Hz

**Please note:** It is recommended to try as best as possible to match frame rates throughout the system to reduce the potential of juddery images. The default pass through setting is designed to match frame rates from Transmitter to Receiver and eliminates this problem. Display settings can also negatively affect motion on an output image from an IP50HD-RX. Settings such as 'Motion Smoothing' should be turned off to avoid this issue. Alternatively, setting the display to 'Game Mode' will turn off all additional processing within a display.



## IP50HD IP Addresses

Each Blustream IP50HD device is shipped with a default fixed IP address (TX: 169.254.100.254, RX: 169.254.100.253). Once the PC network is amended to work in the same IP range as the fixed IP of the Multicast products, it is possible to communicate directly with the built-in web server in each Multicast IP50HD Transmitter or Receiver.

Following configuration using either manual configuration or the ACM200 Web-GUI, or the web-GUI interface of the device itself, the unit will have a different IP address to that of the factory default. The IP address of a configured Multicast product can be found by pressing and holding the 'UP' channel button on the product for 5 seconds, the product IP address will be shown using the front panel display by displaying each of the 4 numeric parts of the IP address in order.

**Please note:** The LCD can only display a 3-digit number, as such the the LCD display will flash 4 times, each with a different number. Adding a dot between these 4 numbers will form the complete IP address of the product, for example:

1 6 9 . 2 5 4 . 0 0 3 . 0 0 1

Entering the fixed IP address (for new units), or the configured IP address of a configured unit, into a web browser on a PC, gives access to the units configuration for monitoring, resetting, firmware upgrading, or further configuration.

On entering the unit IP address into a web browser, a login screen will be shown. The credentials to login are:

Default Username is: [blustream](#)

Default Password is: [1234](#)

The ACM200 web-GUI can also be used to show all connected Multicast products within a system. Blustream also uses an IP Address schema that keeps all Multicast devices in the Link-Local IP range (169.254.xxx.xxx) so that it does not interfere with any other devices on the network as well as making configuration simple.

### Transmitters:

The first product to be assigned an IP address when using the ACM200 web-GUI will be given the IP address of 169.254.3.1. The next Transmitter will be assigned an IP address of 169.254.3.2 and so on....

Once the IP range of 169.254.3.x is filled (254 units), the unit will be auto-assigned of an IP address from 169.254.4.1 and so on...

Once the IP range of 169.254.4.x is filled (254 units), the unit will be auto-assigned of an IP address from 169.254.5.1 up to 169.254.5.254 - this gives a maximum configuration of 762x transmitters in any system using the ACM200 web-GUI.

### Receivers:

The first product to be assigned an IP address when using the ACM200 web-GUI will be given the IP address of 169.254.6.1. The next Receiver will be assigned an IP address of 169.254.6.2 and so on....

Once the IP range of 169.254.6.x is filled (254 units), the unit will be auto-assigned of an IP address from 169.254.7.1 and so on...

Once the IP range of 169.254.7.x is filled (254 units), the unit will be auto-assigned of an IP address from 169.254.8.1 up to 169.254.8.254 - this gives a maximum configuration of 762x receivers in any system using the ACM200 web-GUI.

This part of the guide will explain the use of directly communicating with an individual unit. It is assumed the IP address of the unit is known. Accessing the web-GUI of a Transmitter or Receiver directly should primarily be used as a tool for checking configuration, or problem solving, rather than as a method for setting up a new system.

## IP50HD Web-GUI

When you connect to the IP address of a Transmitter or Receiver you will be greeted with a login screen:

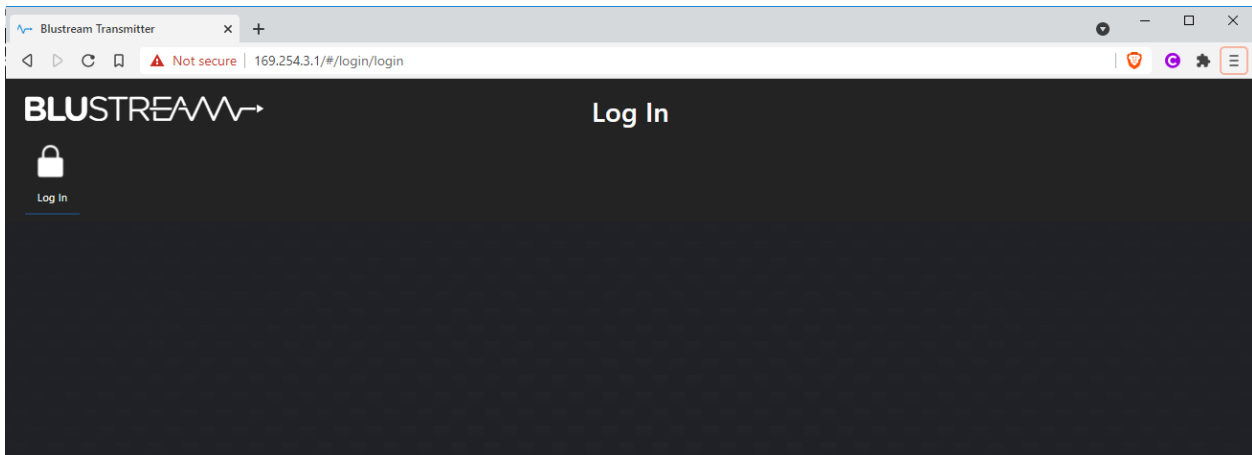

Select the Login button in the top left corner and a username and password prompt will be displayed:

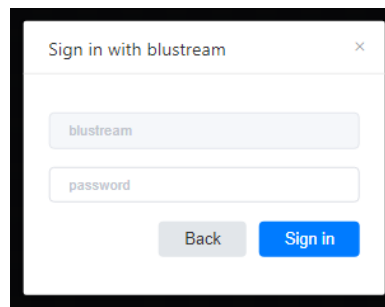

Enter the username and password (the default username and password are listed on the opposing page) and press Sign in to login to the web GUI.

Once signed in you will be taken to the Information page. This page shows the firmware version of the unit as well as all information relating to the IP address and MAC address of the product.

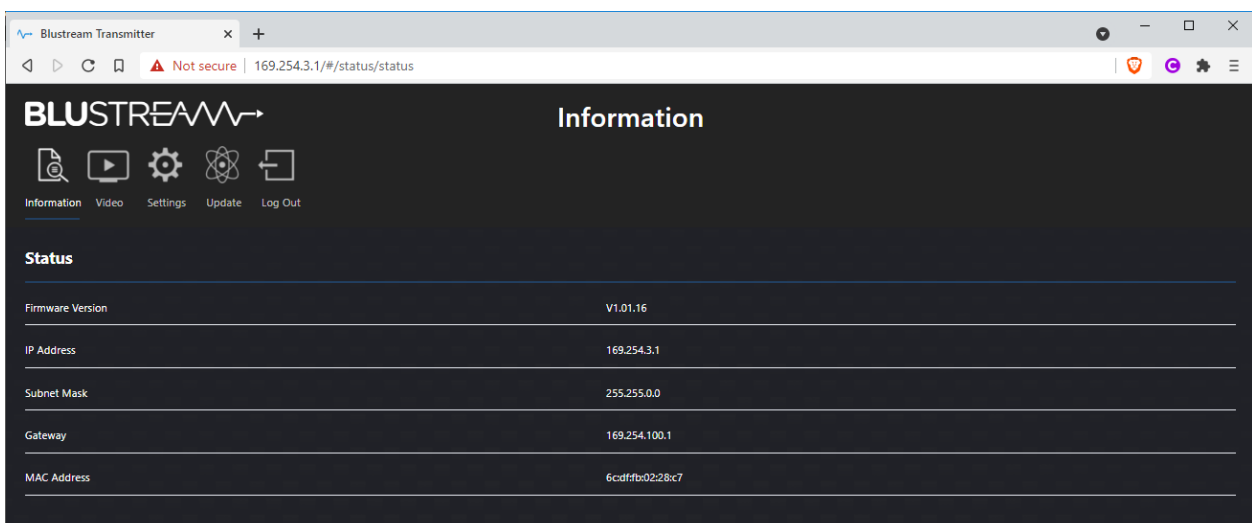

Selecting any of the icons across the top left of the page will allow you to navigate to those sections.

## IP50HD Web-GUI Continued

Transmitter Video Page:

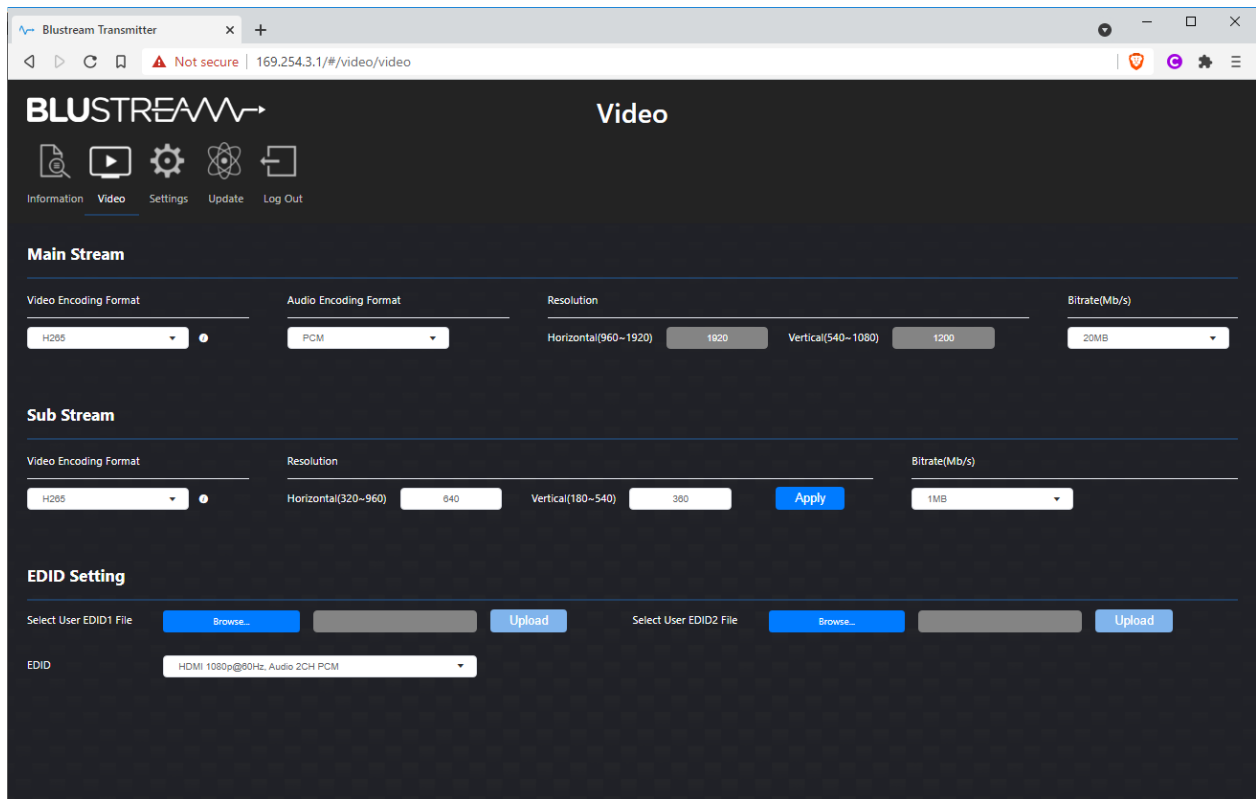

The Transmitter Video Page allows you to adjust settings about the video transmission of the Transmitter.

- Main Stream - This is the main video stream coming from the Transmitter. This is the signal distributed to the IP50HD Receivers.
- Sub Stream - This is the stream used for the live video feed in the ACM200 web-GUI.
- Video Encoding Format - H.265 video encoding provides better quality while H.264 provides greater compatibility for older devices.
- Audio Encoding Format - PCM audio format provides better performance and lower latency. AAC audio format is required for compatibility with external devices.
- Resolution - The encoding resolution of the video stream.
- Bitrate - The encoding bitrate of the audio/video stream. Higher bitrate provides better quality.
- EDID Setting - Allows you to adjust the EDID of the transmitter. Either select from the drop down menu or upload a custom EDID file for custom resolutions.

## IP50HD Web-GUI Continued

Receiver Video Page:

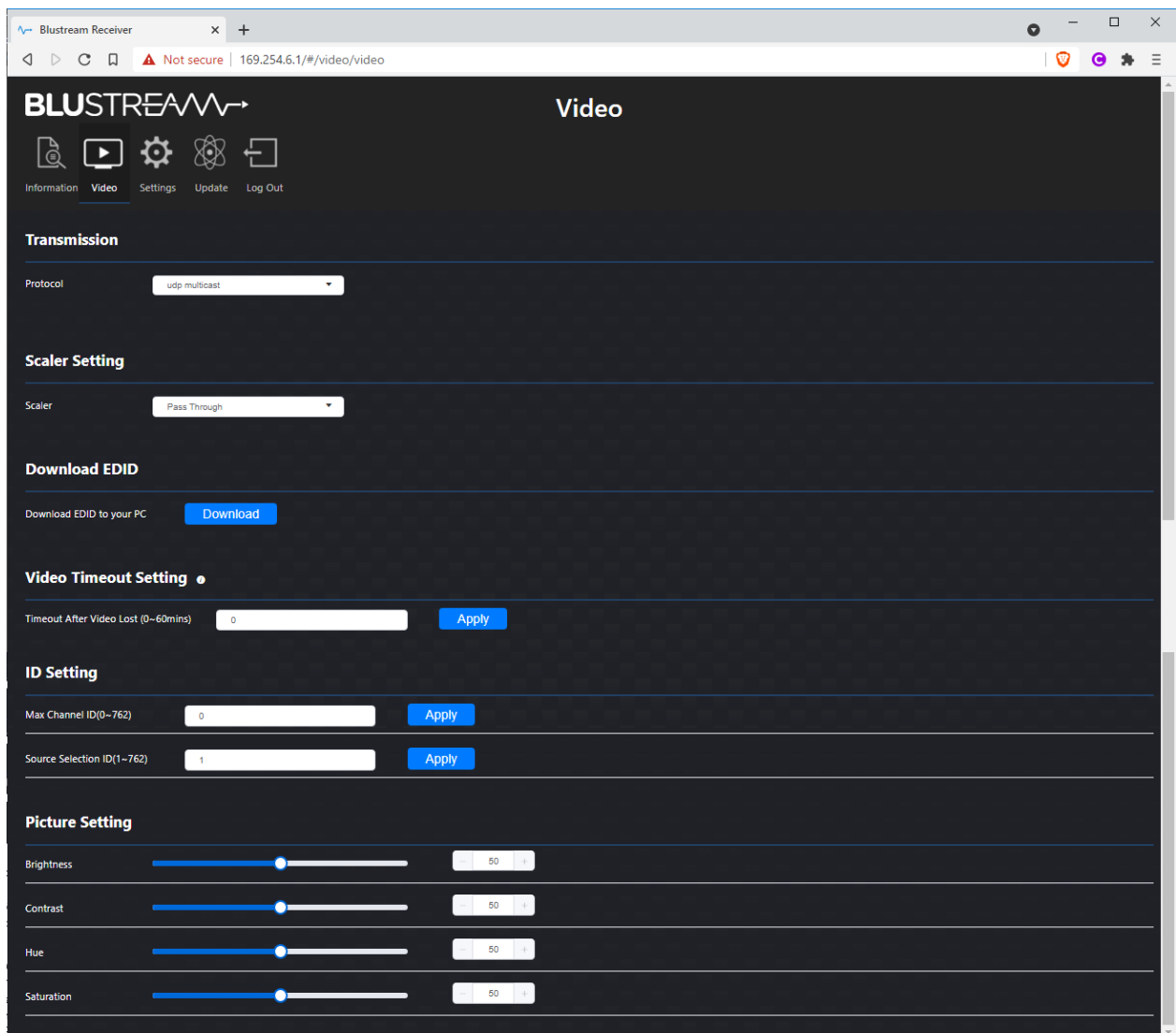

The Receiver Video Page allows you to adjust settings about the video output of the Receiver.

- **Transmission Protocol** - Select between Unicast or Multicast. It is recommended to utilise multicast for larger systems.
- **Scaler Setting** - Set the output scaler resolution of the Receiver. This should be left as Pass-Through unless the display does not support 1080p resolution.
- **Download EDID** - Download the current EDID of the display device connected to the Receiver. This then allows you to load it into a Transmitter or open it in third party software for diagnosis.
- **Video Timeout Setting** - Allows you to specify a time period for the background image to time out. Useful when used with eco mode on displays to allow them to automatically turn off after a period of no usage.
- **Max Channel** - Allows you to specify a maximum number of channels (Transmitters) accessible by the Receiver.
- **Source Selection** - Allows you to change the current source being viewed by the Receiver.
- **Picture Settings** - Allows you to adjust the brightness, contract, hue and saturation of the video output from the Receiver.

## IP50HD Web-GUI Continued

Transmitter and Receiver Settings Page:

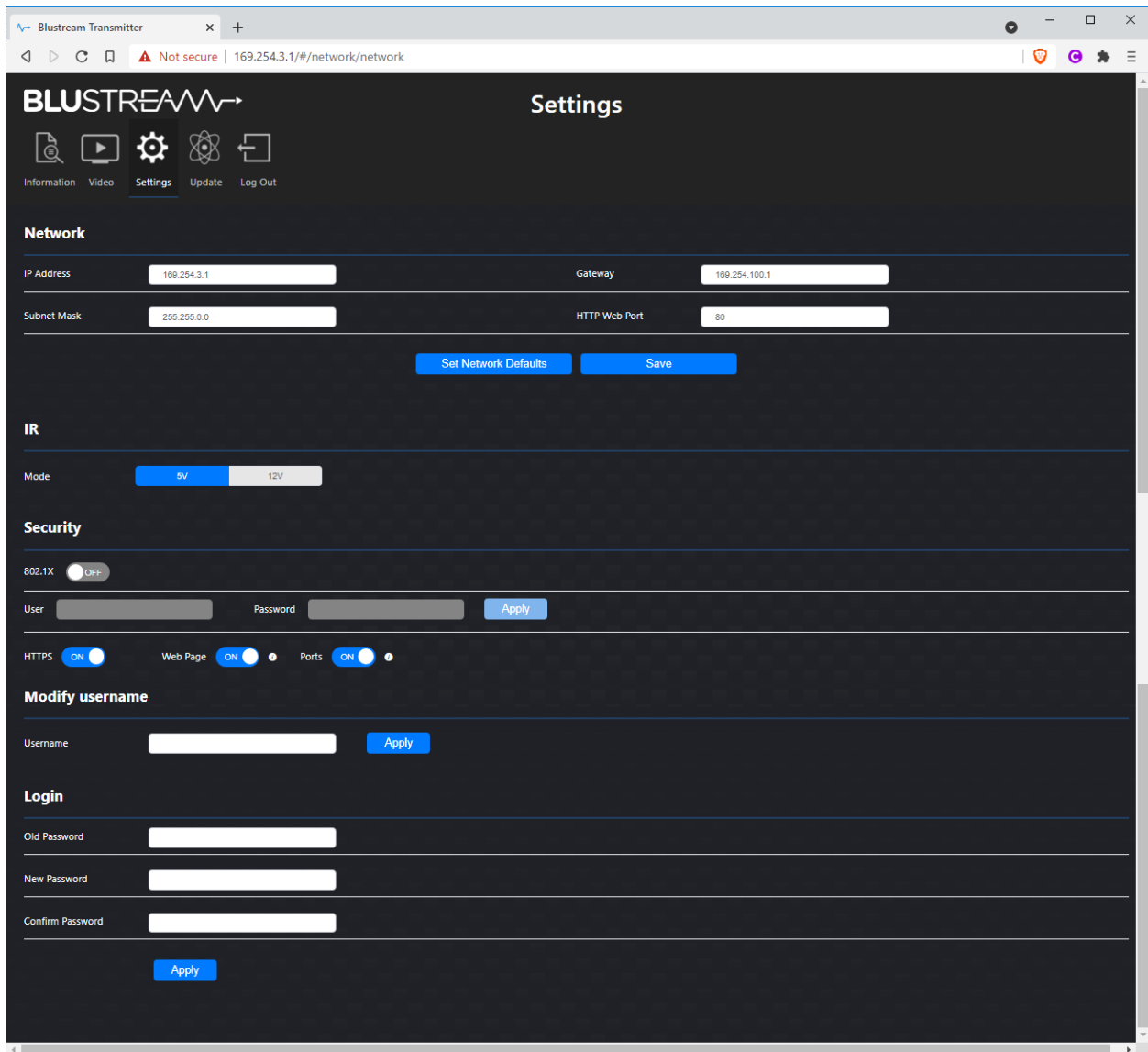

The Transmitter and Receiver Settings Page allows you to adjust settings about the network and security of the Transmitter.

- Network Settings - Adjust the IP address of the Transmitter or Receiver.
- IR Mode - Select 5V or 12V IR mode for compatibility with 3rd party control systems and IR accessories.
- Security Settings - Specify 802.1x security settings as well as enable or disable HTTPS, Web GUI or Telnet/SSH ports. Disabling these features can make the product more secure.
- Username and Password Settings - Change the default username and password settings.

## IP50HD Web-GUI Continued

Transmitter and Receiver Update Page:

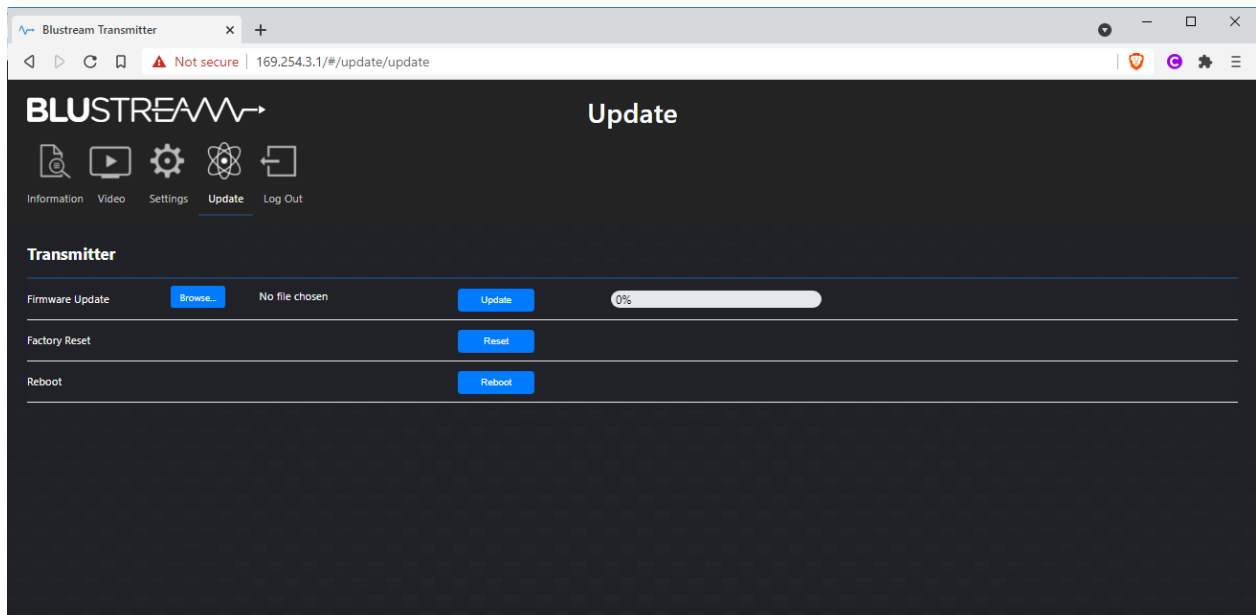

The Transmitter and Receiver Update Page allows you to update the firmware and reset the Transmitter or Receiver.

- Firmware Update - Select the IP50HD-TX or RX firmware update file and press update to update the firmware of the device.
- Factory Reset - Factory resets the product and resets it back to default settings.
- Reboot - Reboots and power cycles the unit with affecting any settings.

**Please note:** DO NOT unplug the power or network connection to the IP50HD-TX or RX during upgrade as this may result in failure to upgrade the firmware, which may lead to possible failure of the unit.

The firmware upgrade process will take several minutes. Do not connect any other Blustream Multicast product to the network that has the same IP address during this time.

# Configuring a Computer IP address

To communicate with the Control Network or Multicast Video Network, the IP Address of the computer being used may need to be amended to communicate with the either network.

- 1) Connect the computer to the Multicast network switch using an Ethernet cable.
- 2) In the Windows toolbar navigate to 'CONTROL PANEL'.
- 3) Select 'NETWORK AND INTERNET'.

## Adjust your computer's settings

View by: **Category** ▾

**System and Security**  
Review your computer's status  
Save backup copies of your files with File History  
Back up and Restore (Windows 7)  
Find and fix problems

**Network and Internet**  
Connect to the Internet  
View network status and tasks  
Choose homegroup and sharing options

**Hardware and Sound**  
View devices and printers  
Add a device  
Adjust commonly used mobility settings

**Programs**  
Uninstall a program

**User Accounts**  
Change account type

**Appearance and Personalisation**  
Change the theme  
Adjust screen resolution

**Clock, Language and Region**  
Add a language  
Change input methods  
Change date, time or number formats

**Ease of Access**  
Let Windows suggest settings  
Optimise visual display

- 5) Select 'NETWORK AND SHARING CENTER'.

Control Panel Home

- System and Security
- **Network and Internet**
- Hardware and Sound
- Programs
- User Accounts

**Network and Sharing Center**  
View network status and tasks | Connect to a network | View network computers and devices

**HomeGroup**  
Choose homegroup and sharing options

**Internet Options**  
Connect to the Internet | Change your homepage | Manage browser add-ons | Delete browsing history and cookies

- 6) Under 'View your Active Networks' see connection types available.  
Select 'Local Area Connection' as this is the method of communication being used with the switch.

Control Panel Home

Change adapter settings  
Change advanced sharing settings

**View your basic network information and set up connections**

View your active networks

**Unidentified network**  
Public network

Access type: **No network access**  
Connections: Ethernet

7) In the next window select 'PROPERTIES'

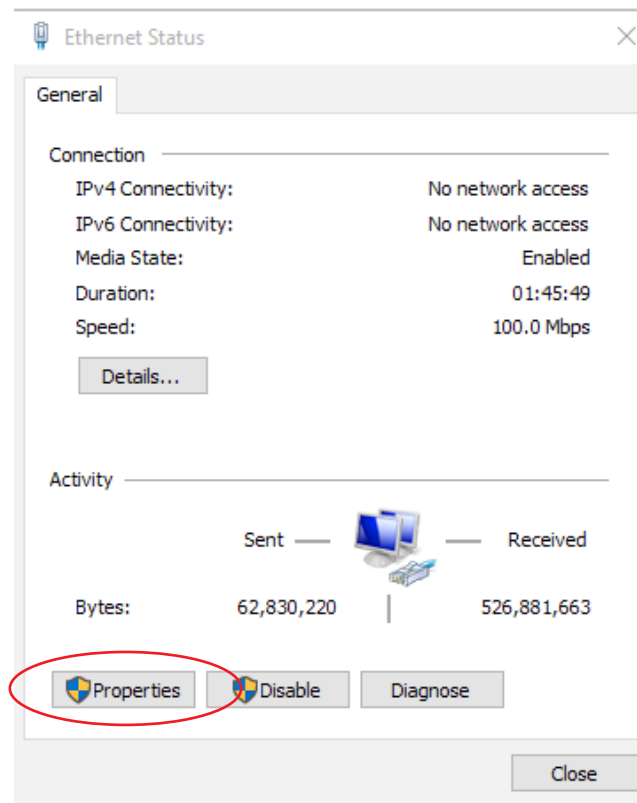

8) A. In the 'NETWORKING' window highlight/select 'INTERNET PROTOCOL VERSION 4 (TCP/IPv4)'  
 B. Select 'PROPERTIES', or double click on 'INTERNET PROTOCOL VERSION 4 (TCP/IPv4)'

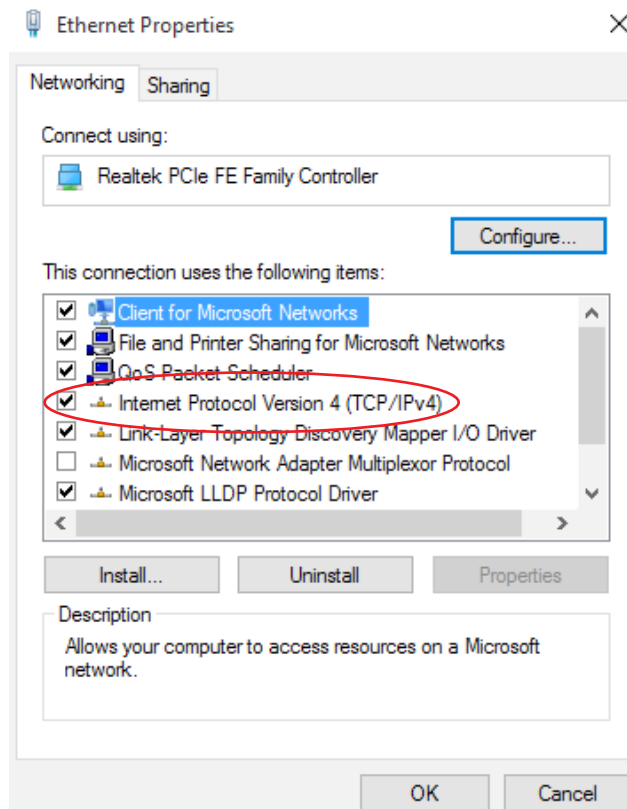



- 9) A. Under the 'General' tab select 'USE THE FOLLOWING IP ADDRESS'
- B. Enter the following FIXED IP network details for the configuration of the **Network Switch** or the **ACM200** (check with the manufacturer of the LAN switch if this address is relevant in advance)

IP Address	192.168.1.1
Subnet Mask	255.255.255.0
Default Gateway	192.169.1.1

- C. Enter the following FIXED IP network details for **Blustream Multicast products**

IP Address	169.254.1.100
Subnet Mask	255.255.0.0
Default Gateway	169.254.1.1

It is important to have the IP address range of the PC configured to the correct range when setting up the LAN switch. Once configuration of the LAN switch has been completed, the IP address range of the PC will need to be amended if using the Multicast Transmitter or Receiver web-GUI's.

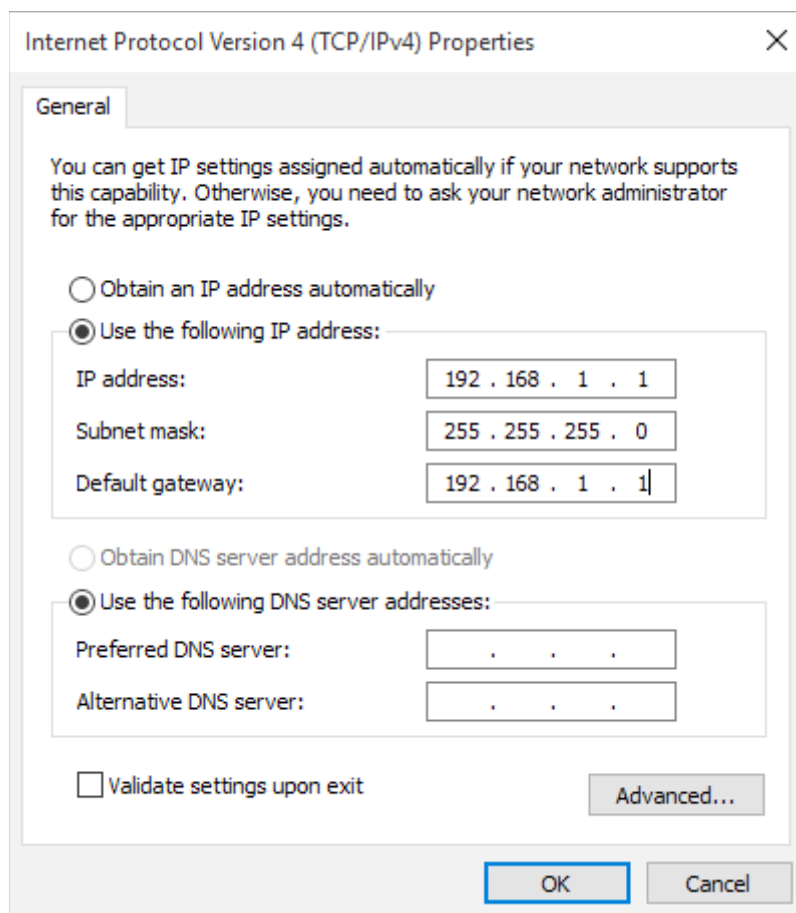

- 10) Click 'OK' and exit the network setup
- 11) Enter the default Network Switch, ACM200 or Blustream Multicast address into a web browser and check for connection to the unit. If the Transmitter and Receiver products have already been configured, enter the address of one of these (it is advised to use 169.254.3.1 - this will be the first default Transmitter IP address).

HDMI Over IP System Design - 3x3 Matrix Configuration  
(Unlimited Amount of Configurations Available)

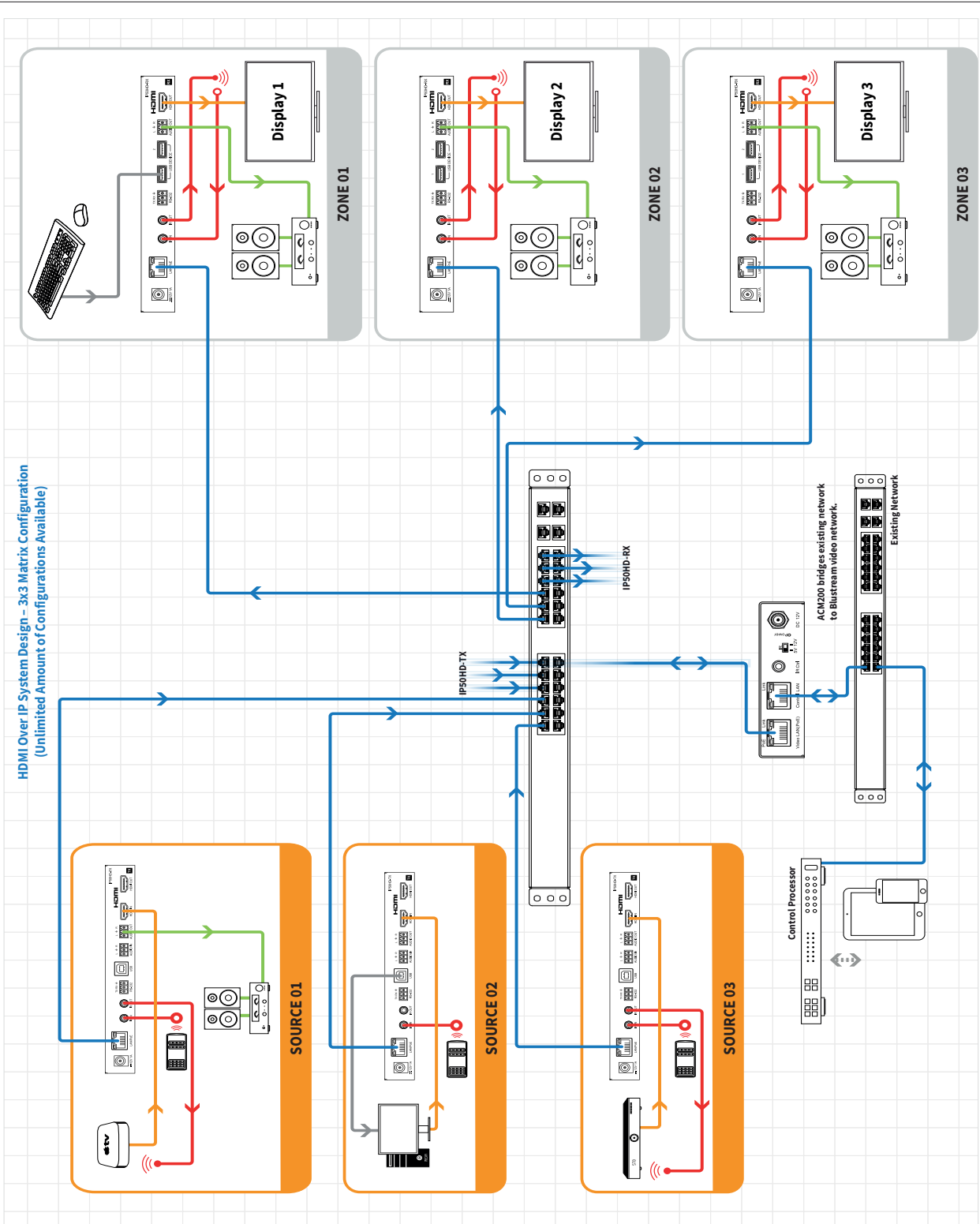

Example Schematic  
IP50HD-TX/RX

- Stereo Audio
- HDMI
- IR
- CAT
- USB

## Supporting Documentation & Downloads

The relevant supporting documents for Blustream Multicast products including firmware updates, switch configuration guides and 3rd party drivers can be found on the Blustream website:  
[www.blustream.com.au](http://www.blustream.com.au) / [www.blustream.co.uk](http://www.blustream.co.uk) / [www.blustream-us.com](http://www.blustream-us.com)

## Specifications

### IP50HD-TX

- Video input: 1x HDMI Type A, 19-pin, female, locking
- Video output: 1x LAN RJ45 connector, 1x HDMI Type A, 19-pin, female, locking
- Audio input: 1x 3-Pin Phoenix connector
- Audio Output Connectors: 1x 3-Pin Phoenix connector
- Ethernet port: 1x LAN RJ45 connector
- RS-232 serial port: 1x 3-Pin Phoenix connector
- USB/KVM Port: 1x USB-Type B
- IR input: 1x 3.5mm stereo jack
- IR output: 1x 3.5mm mono jack
- Mounting kit included
- Dimensions (W x D x H): 190mm x 100mm x 25mm
- Shipping weight (Kit): 0.8kg
- Operating temperature: 32°F to 104°F (0°C to 40°C)
- Storage temperature: -4°F to 140°F (-20°C to 60°C)
- Power Supply: Class 3 IEEE 802.3af PoE PD or 12V/1A DC, screw connector

### IP50HD-RX

- Video Input Connectors: 1x LAN RJ45 connector,
- Video Output Connectors: 1x HDMI Type A, 19-pin, female, locking
- Audio Output Connectors: 1x 3-Pin Phoenix connector
- Ethernet port: 1x LAN RJ45 connector (video extension)
- RS-232 serial port: 1x 3-Pin Phoenix connector
- USB/KVM Port: 2x USB-Type A
- IR Input ports: 1x 3.5mm stereo jack
- IR Output ports: 1x 3.5mm mono jack
- Mounting kit included
- Dimensions (W x D x H): 190mm x 100mm x 25mm
- Shipping weight (Kit): 0.8kg
- Operating temperature: 32°F to 104°F (0°C to 40°C)
- Storage temperature: -4°F to 140°F (-20°C to 60°C)
- Power Supply: Class 3 IEEE 802.3af PoE PD or 12V/1A DC, screw connector

## Package Contents

### IP50HD-TX

- 1 x IP50HD-TX
- 1 x IR Receiver
- 1 x IR Emitter
- 1 x Mounting Kit
- 4 x Rubber Feet

### IP50HD-RX

- 1 x IP50HD-RX
- 1 x IR Receiver
- 1 x IR Emitter
- 1 x Mounting Kit
- 4 x Rubber Feet

## Maintenance

Clean this unit with a soft, dry cloth. Never use alcohol, paint thinner or benzene to clean this unit.

## Certifications

### FCC Notice

This equipment has been tested and found to comply with the limits for a Class B digital device, pursuant to part 15 of the FCC Rules. These limits are designed to provide reasonable protection against harmful interference in a residential installation. This equipment generates, uses, and can radiate radio frequency energy and, if not installed and used in accordance with the instructions, may cause harmful interference to radio communications. However, there is no guarantee that interference will not occur in a particular installation. If this equipment does cause harmful interference to radio or television reception, which can be determined by turning the equipment off and on, the user is encouraged to try to correct the interference by one or more of the following measures:

- Reorient or relocate the receiving antenna.
- Increase the separation between the equipment and receiver.
- Connect the equipment into an outlet on a circuit different from that to which the receiver is connected.
- Consult the dealer or an experienced radio/TV technician for help.

**CAUTION** - changes or modifications not expressly approved by the party responsible for compliance could void the user's authority to operate the equipment.

### CANADA, INDUSTRY CANADA (IC) NOTICES

This Class B digital apparatus complies with Canadian ICES-003.

Operation is subject to the following two conditions: (1) this device may not cause interference, and (2) this device must accept any interference, including interference that may cause undesired operation of the device.



### CANADA, AVIS D'INDUSTRY CANADA (IC)

Cet appareil numérique de classe B est conforme aux normes canadiennes ICES-003.

Son fonctionnement est soumis aux deux conditions suivantes : (1) cet appareil ne doit pas causer d'interférence et (2) cet appareil doit accepter toute interférence, notamment les interférences qui peuvent affecter son fonctionnement.

### CORRECT DISPOSAL OF THIS PRODUCT

This marking indicates that this product should not be disposed with other household wastes. To prevent possible harm to the environment or human health from uncontrolled waste disposal, recycle it responsibly to promote the sustainable reuse of material resources. To return your used device, please use the return and collection systems or contact the retailer where the product was purchased. They can take this product for environmentally safe recycling.

Notes...



[www.blustream.com.au](http://www.blustream.com.au)  
[www.blustream-us.com](http://www.blustream-us.com)  
[www.blustream.co.uk](http://www.blustream.co.uk)