

## ▶ HD11AU User Manual

### Thank you for purchasing this product.

For optimum performance and safety, please read these instructions carefully before connecting, operating or adjusting this product. Please keep this manual for future reference.



### Surge protection device recommended

This product contains sensitive electrical components that may be damaged by electrical spikes, surges, electric shock, lightning strikes, etc. Use of surge protection systems is highly recommended in order to protect and extend the life of your equipment.

## Contents

Introduction	03
Features	03
Panel Descriptions	04
Specifications	05
Package Contents	05
Maintenance	05
Certifications	05
Schematics	06-07

# Introduction

Our HD11AU is the perfect solution for either de-embedding or embedding audio within the HDMI signal path. This solution allows you to breakout up to 5.1ch audio signals.

Connect the HD11AU between your source and display via HDMI, then select whether de-embedding or embedding audio is required.

---

## FEATURES:

---

- Extract audio from the HDMI video input
- Extract audio with or without an actual display connected
- Provides both coaxial digital and analogue left / right audio outputs concurrently
- Can remove the audio from the HDMI input signal and embed analogue left / right audio to the HDMI output signal
- Analogue left / right out supports 2ch PCM input signal only
- Support 3D video & 4K 60Hz 4:2:0
- HDCP 1.4 compatible
- Small compact size

# Panel Descriptions

## Front Panel

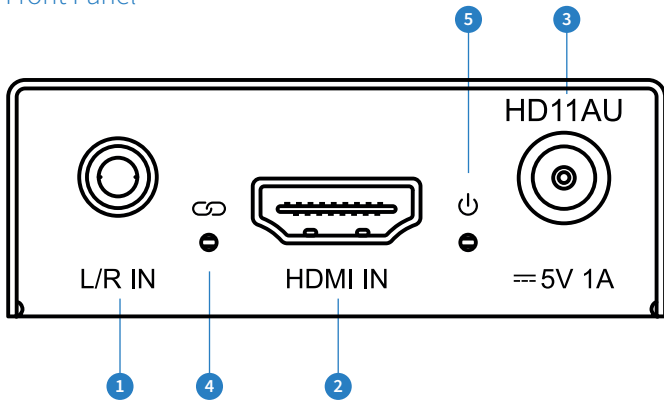

- 1 Left / Right Analogue audio input - 3.5mm Stereo jack
- 2 HDMI input
- 3 Power port – Use supplied 5V / 1A DC adaptor
- 4 HDMI input status – Lit when HDMI signal detected
- 5 Power status – Lit when unit is powered
- 6 Coaxial digital output – Used when audio is de-embedded from HDMI

## Back Panel

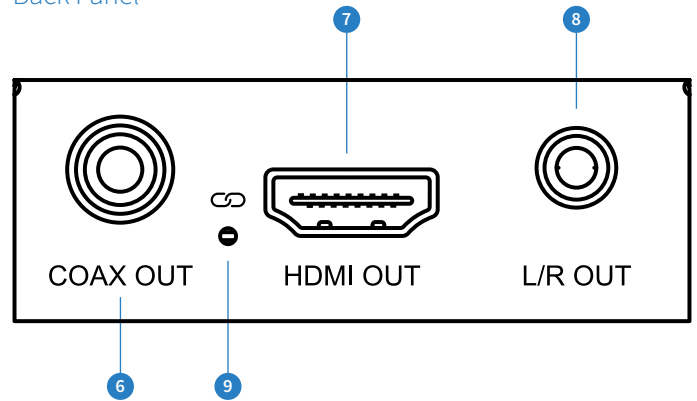

- 7 HDMI output
- 8 Left / Right Analogue audio output. Extract audio from HDMI input and convert to 2ch. NOTE: Source audio must be PCM
- 9 HDMI output status – Lit when HDMI signal detected

## Side Panel

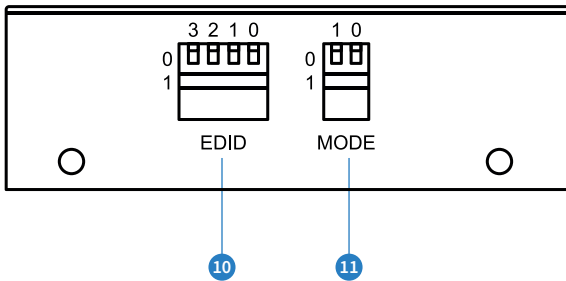

- 10 EDID management DIP switches – See adjacent table for settings
- 11 Mode Dip switches – See information below for mode settings

### Mode Selection DIP Switches

**Dip Switch 1 = 0:** Input HDMI HPD (Hot Plug Detected) depends on output HDMI HPD

**Dip Switch 1 = 1:** Input HDMI HPD forced high (for installations where no output device is connected)

**Dip Switch 0 = 0:** HDMI audio de-embed mode

**Dip Switch 0 = 1:** Analogue audio embed mode - removes the audio from HDMI input signal and embeds the analogue L/R audio input onto the HDMI output signal

### EDID Management DIP Switches

3	2	1	0	EDID Type
Combination of DIP Positions				
0	0	0	0	Copy EDID from Display
0	0	0	1	1080p 2.0ch
0	0	1	0	1080p 5.1ch
0	0	1	1	1080p 7.1ch
0	1	0	0	1080i 2.0ch
0	1	0	1	1080i 5.1ch
0	1	1	0	1080i 7.1ch
0	1	1	1	1080p 3D 2.0ch
1	0	0	0	1080p 3D 5.1ch
1	0	0	1	1080p 3D 7.1ch
1	0	1	0	4K60 4:2:0 2.0ch
1	0	1	1	4K60 4:2:0 5.1ch
1	1	0	0	4K60 4:2:0 7.1ch
1	1	0	1	DVI 1280x1024 (no audio)
1	1	1	0	DVI 1920x1080 (no audio)
1	1	1	1	DVI 1920x 1200 (no audio)

## Specifications

**Audio Input Connectors:** 1 x Analogue left / right audio (3.5mm stereo jack)

**Audio Output Connectors:** 1 x Coaxial digital audio & 1 x Analogue left / right audio (3.5mm stereo jack)

**Video Input Connectors:** 1 x HDMI Type A

**Video Output Connectors:** 1 x HDMI Type A

**Casing Dimensions (W x H x D):** 71mm x 23mm x 60mm

**Dimensions Including Connections (W x H x D):** 83mm x 23mm x 60mm

**Shipping Weight:** 0.4kg

**Operating Temperature:** 32°F to 104°F (0°C to 40°C)

**Storage Temperature:** -4°F to 140°F (-20°C to 60°C)

---

## Package Contents

- 1 x HD11AU
- 1 x 5V/1A DC Power Supply
- 1 x Mounting Kit
- 1 x User Manual

---

## Maintenance

Clean this unit with a soft, dry cloth. Never use alcohol, paint thinner or benzene to clean this unit.

---

## Certifications

### FCC NOTICE

This equipment has been tested and found to comply with the limits for a Class B digital device, pursuant to part 15 of the FCC Rules. These limits are designed to provide reasonable protection against harmful interference in a residential installation. This equipment generates, uses, and can radiate radio frequency energy and, if not installed and used in accordance with the instructions, may cause harmful interference to radio communications. However, there is no guarantee that interference will not occur in a particular installation. If this equipment does cause harmful interference to radio or television reception, which can be determined by turning the equipment off and on, the user is encouraged to try to correct the interference by one or more of the following measures:

- Reorient or relocate the receiving antenna.
- Increase the separation between the equipment and receiver.
- Connect the equipment into an outlet on a circuit different from that to which the receiver is connected.
- Consult the dealer or an experienced radio/TV technician for help.

**CAUTION** - changes or modifications not expressly approved by the party responsible for compliance could void the user's authority to operate the equipment.

### CANADA, INDUSTRY CANADA (IC) NOTICES

This Class B digital apparatus complies with Canadian ICES-003.

Operation is subject to the following two conditions: (1) this device may not cause interference, and (2) this device must accept any interference, including interference that may cause undesired operation of the device.

### CORRECT DISPOSAL OF THIS PRODUCT

This marking indicates that this product should not be disposed with other household wastes. To prevent possible harm to the environment or human health from uncontrolled waste disposal, recycle it responsibly to promote the sustainable reuse of material resources. To return your used device, please use the return and collection systems or contact the retailer where the product was purchased. They can take this product for environmentally safe recycling.

BLUSTREAM

Example Schematic  
HD11AU - Audio Embedding

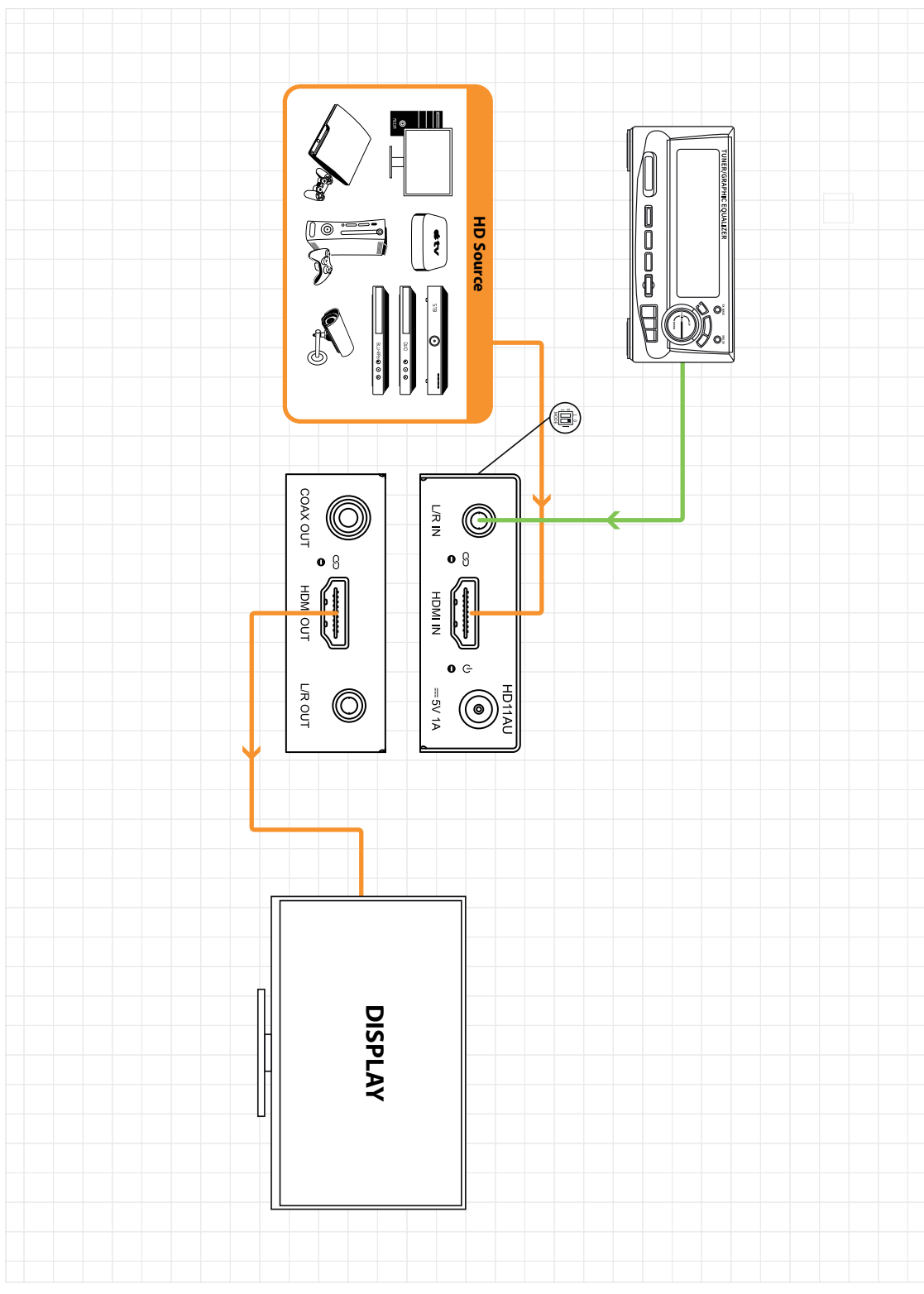
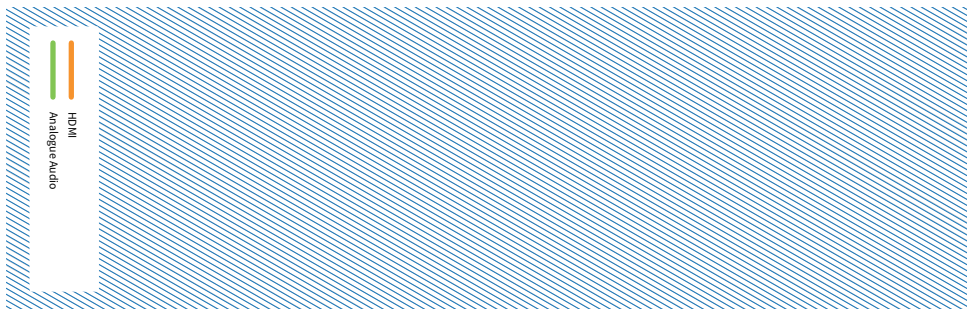

BLUSTREAM

Example Schematic  
HD111AU - Audio De-Embedding

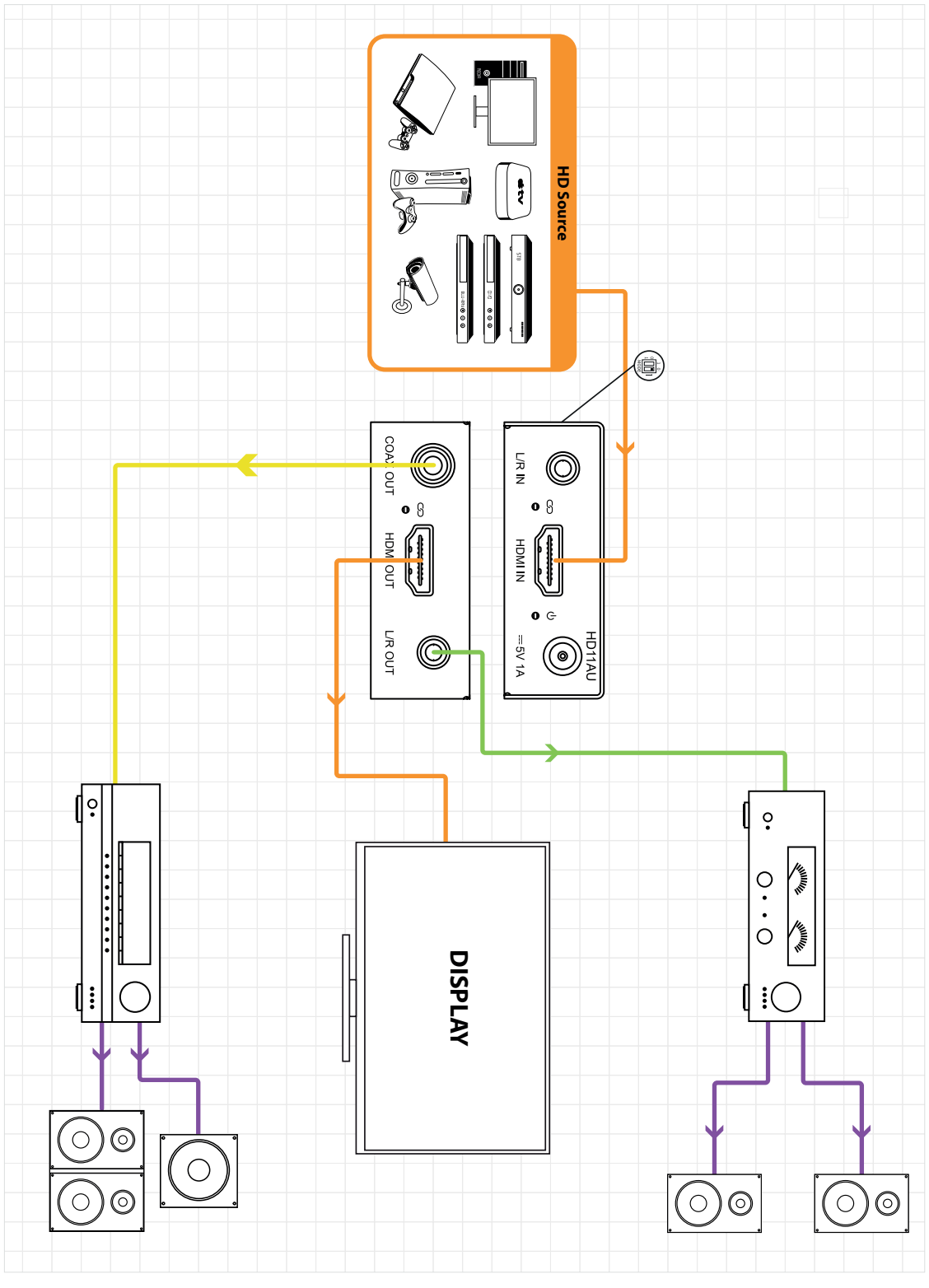
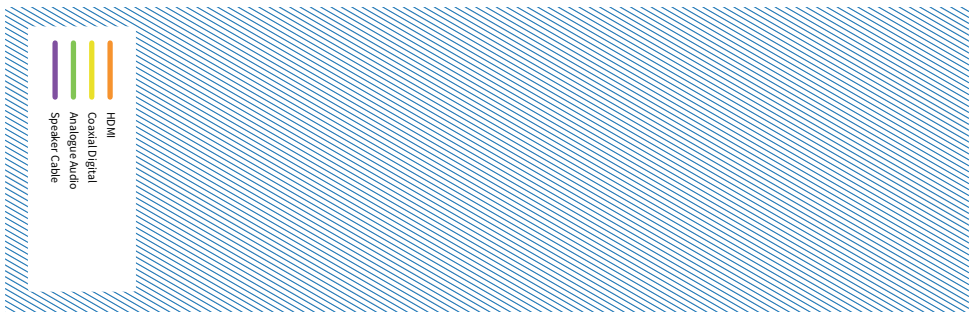



[www.blustream-us.com](http://www.blustream-us.com)  
[www.blustream.com.au](http://www.blustream.com.au)  
[www.blustream.co.uk](http://www.blustream.co.uk)