

► **NPA70DA**  
User Manual

## Thank you for purchasing this product.

For optimum performance and safety, please read these instructions carefully before connecting, operating or adjusting this product. Please keep this manual for future reference.



### Surge Protection Device Recommended

This product contains sensitive electrical components that may be damaged by electrical spikes, surges, electric shock, lightning strikes, etc. Use of surge protection systems is highly recommended in order to protect and extend the life of your equipment.

# Contents

Introduction	03
Features	03
Front Panel Description	04
Rear Panel Description	04
Speaker Connections	05
Audio Connections	05
Trigger Connection	06
IR Connection	06
Network Connections	06
Dante® Audio & Dante® Controller	07-08
Advanced Dante® Settings	08
Web GUI Control	09-13
Schematic	14
Telnet & RS-232 Control Port	15-16
Specifications	17
Package Contents	17
Maintenance	17
Acknowledgements	18
Certifications	18

# Introduction

Our NPA70DA networked audio zone amplifier delivers advanced audio integration within a commercial or residential AV installation.

The NPA70DA features a 2 x 35W digital amplifier (1 x 70W mono) or 70V / 100V hi-level constant voltage output and Dante® audio integration.

The NPA70DA can be powered via PoE++ from a compatible network switch, or locally should the switch not support PoE++. The unit also includes the ability to lower the amplifier power output subject to PoE capabilities, support for combined or independent LAN and Dante® connections, DSP with a 31 band EQ, audio delay for lip sync correction, and control via front panel, IR, RS-232, TCP/IP, web-GUI or 12V trigger.

---

## FEATURES:

---

- Advanced network audio amplifier with Dante® integration
- Supports 2 x 35W @ 4 / 8 ohm, 1 x 70W @ 4 / 8 ohm or 70 / 100V constant output for multiple speakers with longer cable runs
- Supports power via PoE++ on Dante® LAN connection or local power supply\*
- Dual network option - independent Dante® and LAN control ports, or combined to a single LAN
- 2ch Dante® / AES67 audio input
- DSP with 31 band EQ with +3dB/-10dB and audio delay
- Local 12V input trigger for automated power control
- Control via front panel, IR, RS-232 and IP
- Auto standby mode with signal sensing
- In-built web-GUI for setup and control

*\* Amp power limited when using PoE+*

## Front Panel Description

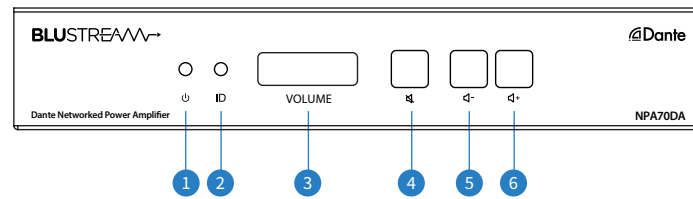

- 1 Power Status LED
- 2 ID LED - Illuminates to assist in identification of the device
- 3 Volume Level LED's - Illuminates to show current volume level
- 4 Volume Mute Button - Toggles audio mute on or off
- 5 Volume - Button - Decrease master output volume
- 6 Volume + Button - Increase master output volume

## Rear Panel Description

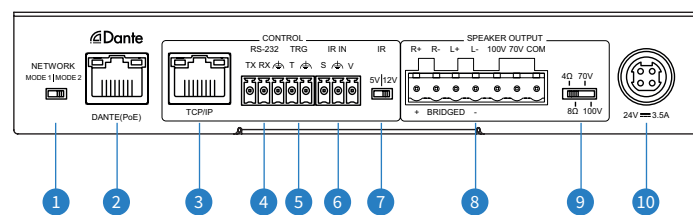

- 1 Network Mode Switch - Mode 1 allows Dante® audio and TCP/IP and web-GUI control via the Dante® PoE port  
- Mode 2 allows Dante® audio via the Dante® PoE Port, and TCP/IP and web-GUI control via the TCP/IP port
- 2 Dante® (PoE++) Port - RJ45 connector supporting PoE++ to power NPA70DA from the network switch
- 3 TCP/IP Port - RJ45 connector for TCP/IP and web-GUI control of the device (When Network mode is set to 2)
- 4 RS-232 - Phoenix connector for RS-232 control of the device
- 5 Trigger Input - Phoenix connector triggers device power on/off. Low level (0V) to turn amp on, high level (5-12V) to turn amp off
- 6 IR Input - 3-pin Phoenix connector to connect to Blustream IR receiver for IR control of the device
- 7 IR Voltage Switch - Select between 5V or 12V IR voltage. **Please note:** included Blustream IR accessories are 5V
- 8 Speaker Output - Phoenix connector to connect speaker outputs, see Speaker Connections section for more information
- 9 Speaker Impedance Switch - Select low impedance (LO-Z, 4-8 ohm) speakers, or high impedance (HI-70V or HI-100V) speakers
- 10 Power Port - Use included 24V/3.5A DC power adaptor if not powered via PoE++ device

# Speaker Connections

The NPA70DA supports both Low Impedance (4-8ohm) speakers as well as High Impedance (70V-100V) speakers. It is necessary to configure the Speaker Impedance Switch as well as wire up the speakers according to the specific speakers you are using. Wiring examples for each of the available configurations are as follows:

## Low Impedance (4-8ohm) Stereo Speakers:

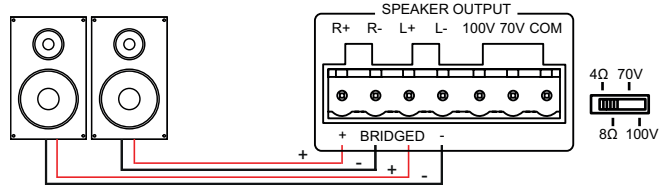

## Low Impedance (8ohm) Mono Speaker:

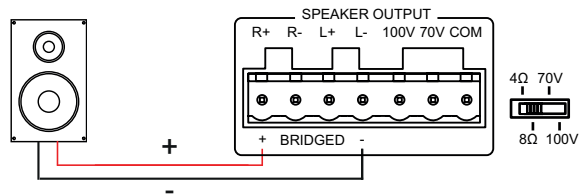

## High Impedance 70V Speakers:

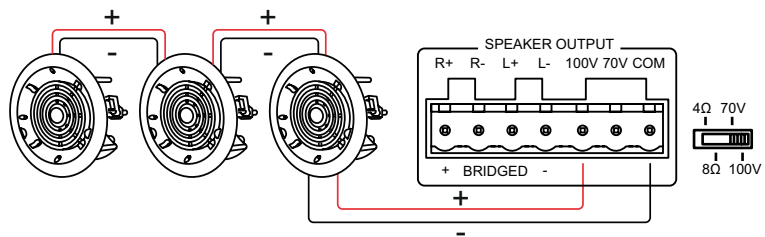

## High Impedance 100V Speakers:

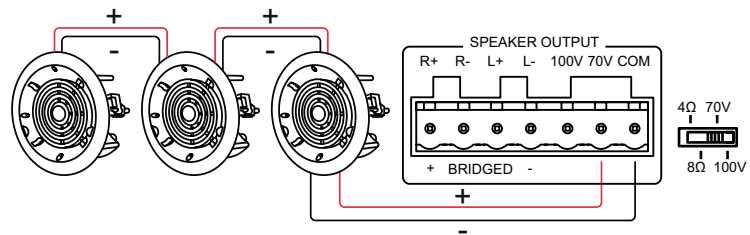

# Amplifier Output

The NPA70DA amplifier is capable of outputting the same power at both 4 ohms and 8 ohms. The amplifier output power varies depending on the input power supply or PoE adapter connected to it, it does this by adjusting the internal gain to allow you to get the most of the amplifier. Please ensure that you select the correct impedance option via the speaker impedance selection switch on the rear of the device.

POWER SOURCE	WRMS PER CHANNEL @ 4/8OHM	WRMS BRIDGED @ 8OHM
24V/3.5A DC	2x 35W	70W
PoE++ Type 4 Class 8	2x 25W	50W
PoE++ Type 4 Class 7	2x 20W	40W
PoE++ Type 3 Class 6	2x 15W	30W
PoE++ Type 3 Class 5	2x 10W	20W
PoE+ Type 2 Class 4	2x 3.25W	7.5W

## Trigger Connection

The NPA70DA features a trigger input to allow 3rd party devices to trigger the units power on or off. When the trigger input senses a low voltage level (0V) it will enable the amplifier output, while when it senses a high voltage level (5-12V) it will disable the amplifier out. This feature is enabled by default and can be adjusted via the web-GUI, or control API.

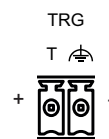

## IR Connection

The NPA70DA supports both 5V and 12V IR receivers via the IR input. There is a toggle switch to the right of the IR input port to specify the voltage required. Please note: if using a Blustream IR receiver, the switch should be in the 5V position.

The wiring for a Blustream IR receiver is as follows:

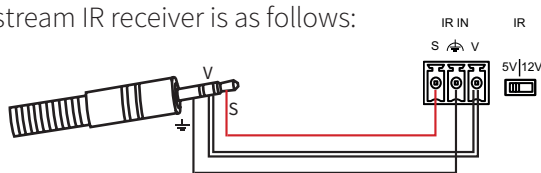

PIN	IR CONNECTION	COLOUR
S	Tip	Red
GND	Sleeve	Black
V	Ring	White

## Network Connections

The NPA70DA features 2 x RJ45 sockets for combined or independent Dante® network and Control network connectivity. The Network Mode switch, located next to the RJ45 socket, determines the mode of operation for the RJ45 sockets as follows:

- Mode 1 allows combined Dante® audio, TCP/IP, and web-GUI control via the Dante® PoE++ port
- Mode 2 allows Dante® audio via the Dante® PoE Port, then TCP/IP and web-GUI control via the TCP/IP port

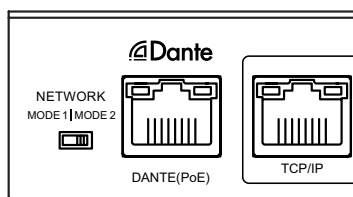

## Dante® Audio & Dante® Controller

The NPA70DA features a Dante® Audio input as its only source input. The current source that is selected via Dante® Controller will always be the source that is output via NPA70DA.

Dante® Controller software is required in order to setup and configure the NPA70DA as well as control your Dante® network. Audinate provide extensive training videos and documentation on their website. This can be found here: <http://www.audinate.com/products/software/dante-controller>

Upon connecting the NPA70DA to a compatible network, the Dante® Controller software should automatically discover the device. The NPA70DA will appear in the Dante® Controller with the name “NPA70DA”. On the “Routing” screen it is possible to then create audio routing between Dante® transmitters and receivers within the same system.

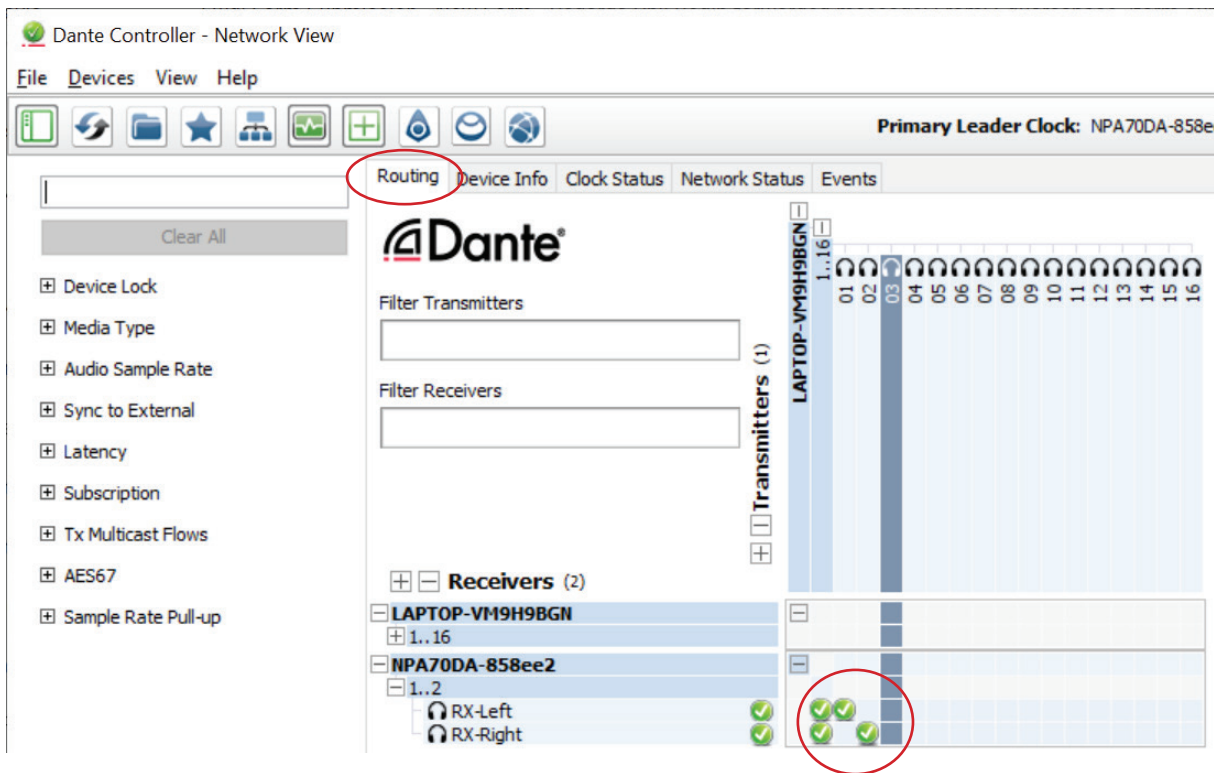

## Dante® Controller

By default, the NPA70DA is shipped with the network settings set to obtain an IP Address automatically. This means that if a DHCP server is present on the network, the NPA70DA will be provided with an IP Address. If no DHCP server is present then the NPA70DA will receive a default IP Address in the 169.254.xxx.xxx range. To change the IP Address of the NPA70DA, enter the “Network Config” menu in the “Device Info” screen of the Dante® Controller software:

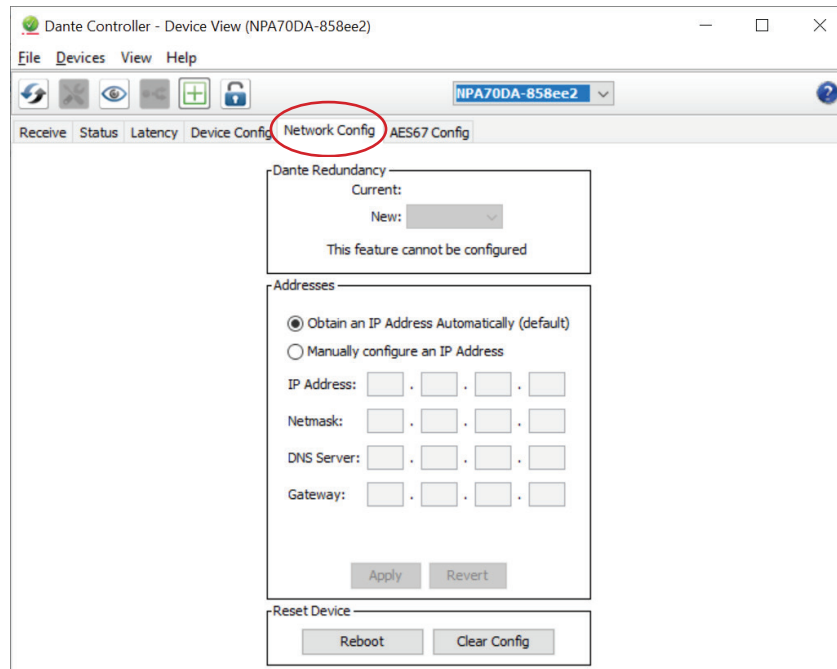

## Advanced Dante® Settings

It is possible to change various Dante® related settings of the NPA70DA under the “Device Info” screen in the Dante® Controller software. To do so, select the “Device Config” menu.

Here it is possible to adjust the sample rate of the NPA70DA. **Please note:** that Dante® products can only transmit or receive audio from other Dante® products that are set up with the same sample rate. A mismatch in sample rate may stop audio from transmitting.

Under the “Device Config” screen the latency of the NPA70DA can be configured with 1, 2 or 5 milliseconds delay.

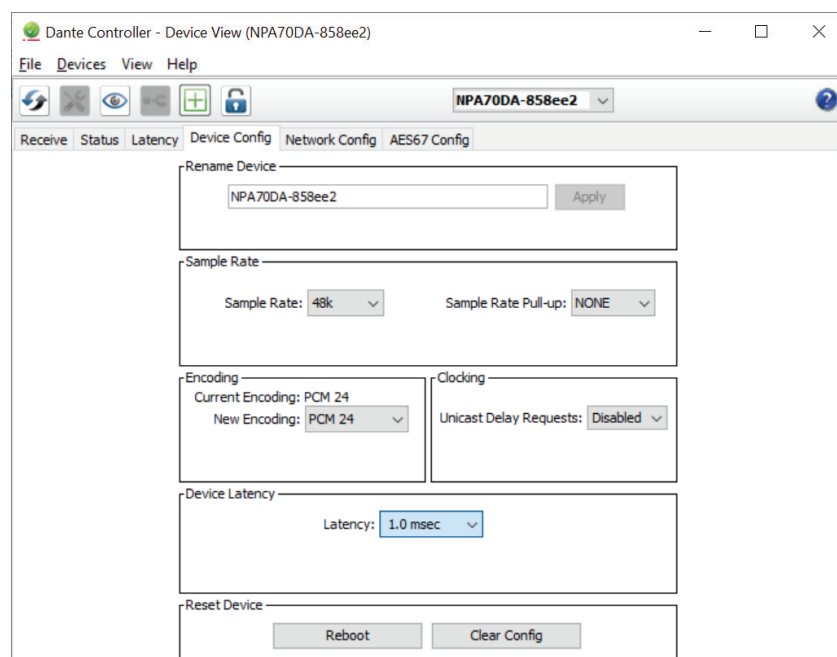



# Web-GUI Control

The NPA70DA features an in-built web-GUI for control and configuration of the unit. By default the device is set to DHCP, however if a DHCP server (eg: network router) is not installed the device IP address will revert to below details:

Default **Username:** [blustream](#)      Default **Password:** [1234](#)      Default **IP Address:** [192.168.0.200](#)

The device can also be accessed via its mDNS name which is defaulted to: <http://NPA70DA.local/>

The web-GUI supports multiple users along with multiple user permissions as follows:

**Guest Account** - This account does not require a user to login. The Guest account can only change sources for each zone. Guest access can be changed by the Admin, limiting inputs or outputs as necessary. The Guest account can be disabled.

**User Accounts** - User accounts can be utilised, each with individual login details. User accounts can be assigned permissions to specific areas and functions. A User must log in to make use of these functions.

**Admin Account** - This account allows full access to all functions of the unit as well as assigning users with permissions as required.

## Login Page:

The Login Page allows a user or admin to login and access additional functionality within the web GUI.

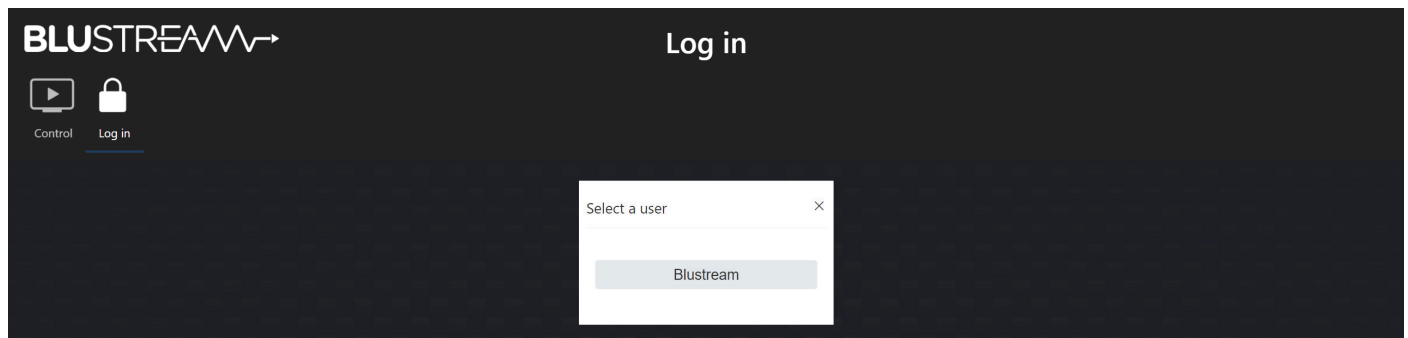

Once a user is selected from the list it is required to enter the password for that user in order to sign in.

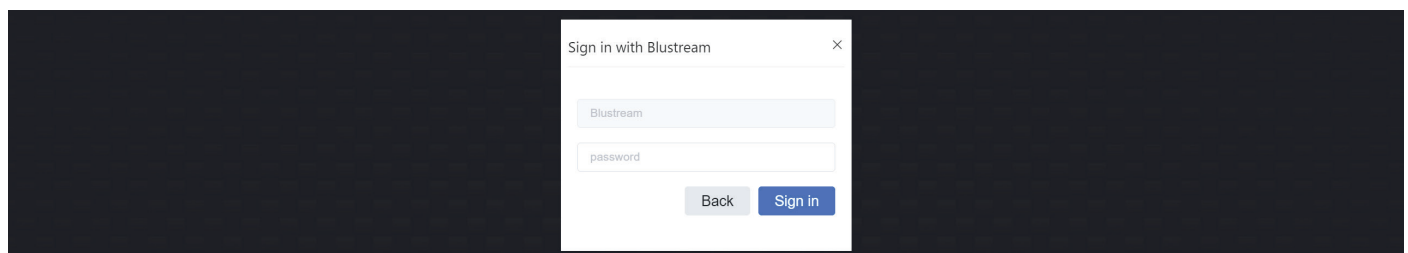

Please note: the first time the Admin logs into the web GUI, the default admin password will need to be changed. It is important to record this password as there is no way to recover it in the event that it is forgotten.

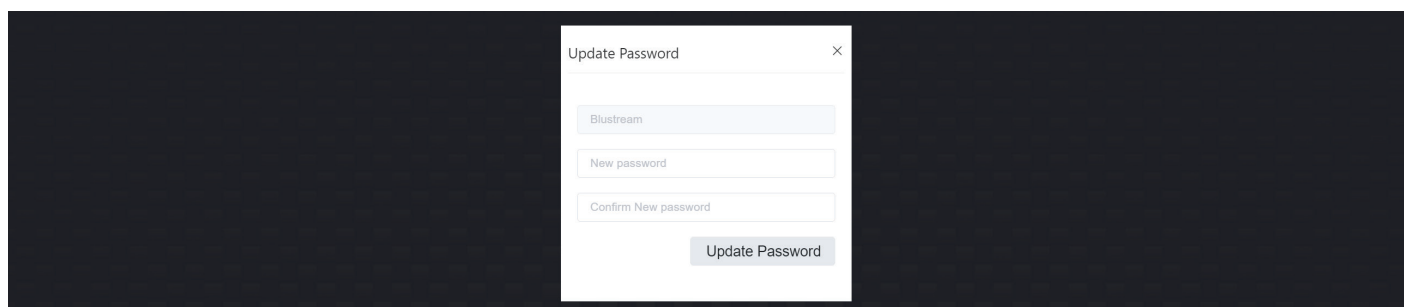

**Guest Control Page:**

The Guest Control Page allows a guest to adjust the master output volume of the unit by using the volume slider or the volume up / down buttons as well as the mute toggle button.

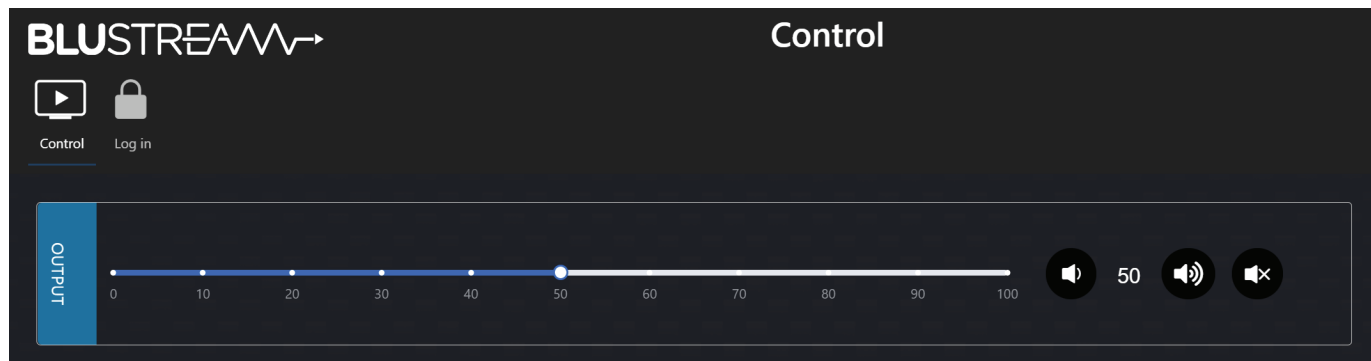

**User Control Page:**

The User Control Page allows a user to adjust the volume for the input our output, as well as mute the audio signal. The input volume adjustment could act as an audio limit function to limit the maximum output volume. A User can also adjust the signal mix (single channel only, stereo or summed mono), audio delay or 31 band graphic eq with +3dB / -10dB of adjustment.

The user can also update their password via the Update Password button, or log out via the Log Out button.

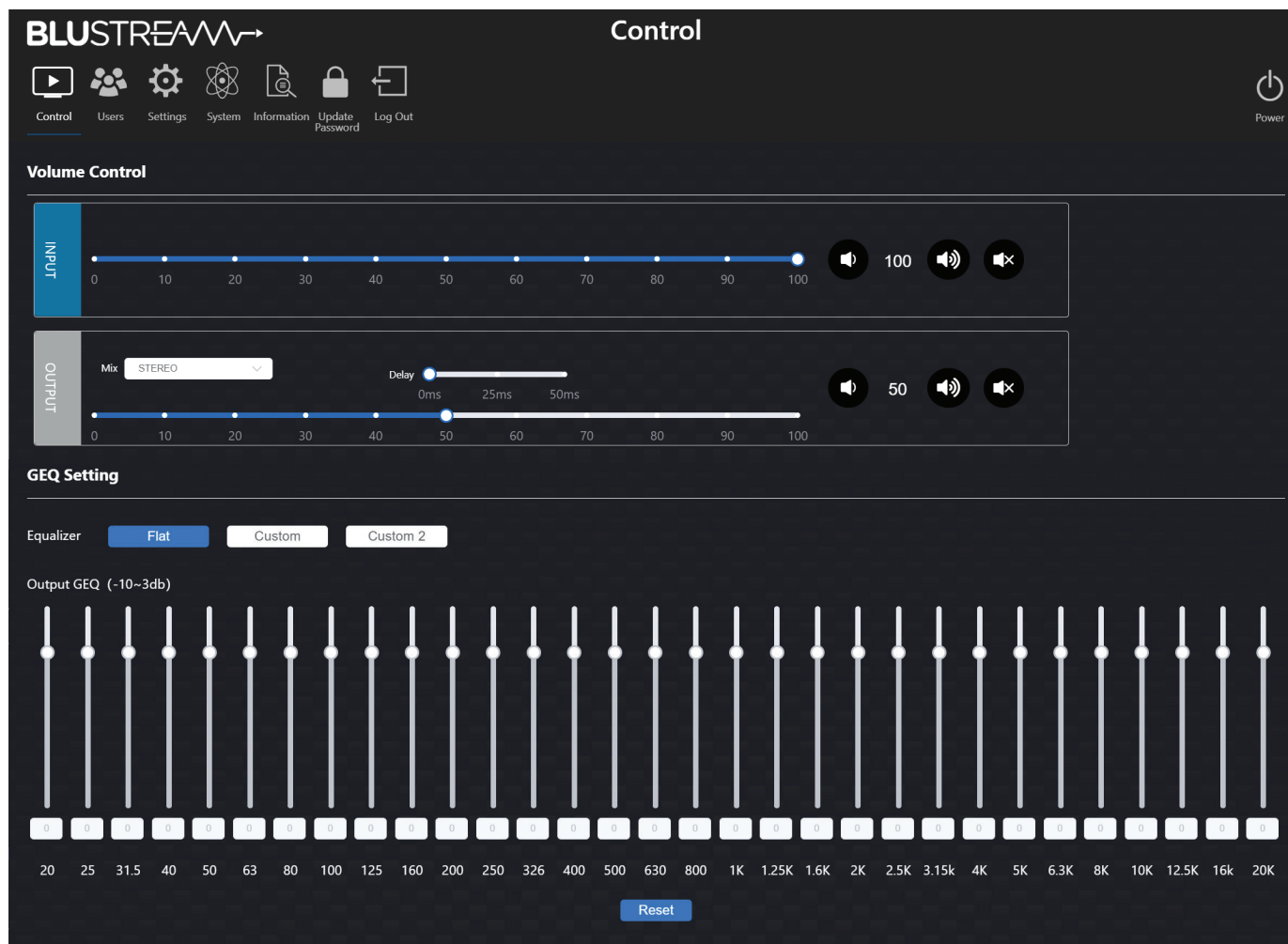

**User Page:**

The Users page allows the admin to add, remove or disable users. Updating passwords of a user can be carried out from here also.

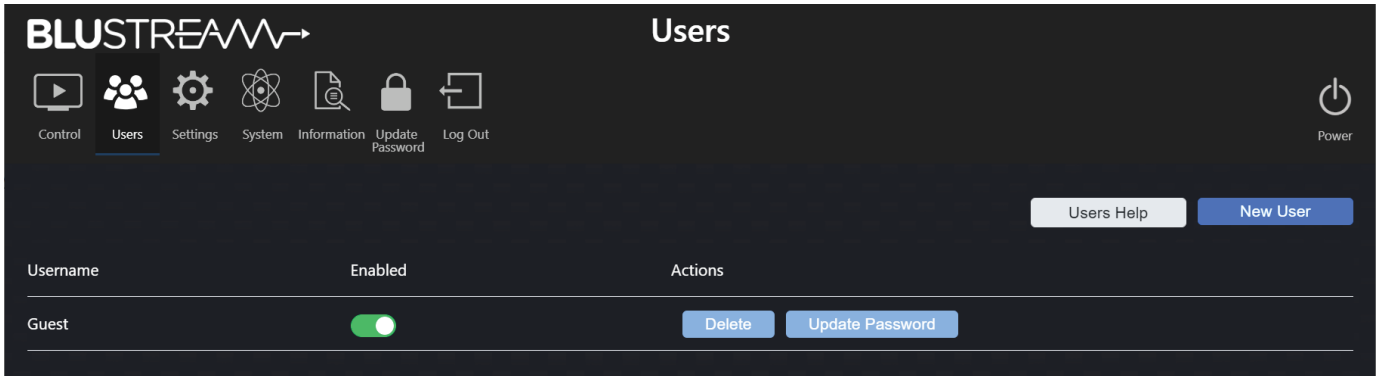

**Settings Page:**

The Settings page allows users to change settings specific to the network configuration of the NPA70DA such as the devices IP address and port settings. You can also adjust the mDNS or Domain Name for the device, which can also be used to access unit via, for example: <http://NPA70DA.local/>

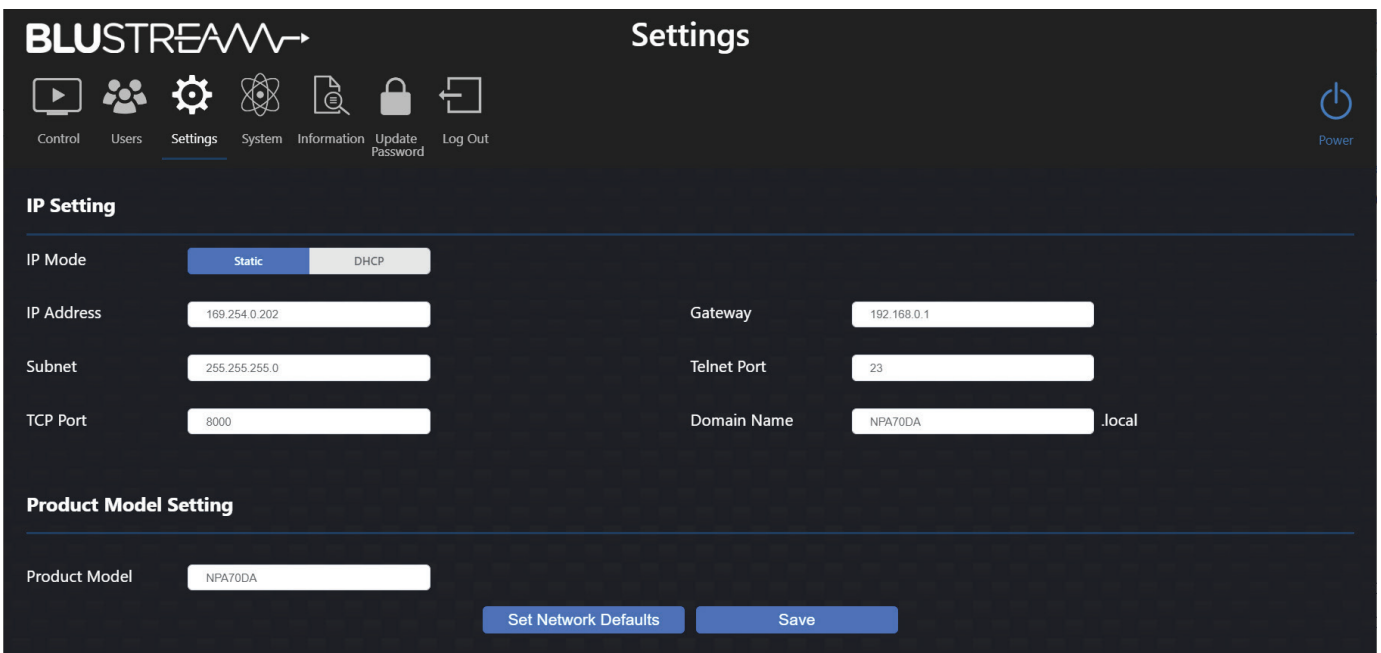

**System Page:**

The System page allows users to change the system configuration of the NPA70DA such as:

- Identification - flashes the ID LED on front of the unit for the specified time period
- Key Lock On/Off - enable or disable to front panel keys from functioning
- Power On/Off - turn the unit on or off
- Input Trigger On/Off - enable or disable input trigger function
- Power Mode - if the NPA70DA is connected to DC power supply, then PoE power modes will not be selectable. If the NPA70DA is connected via PoE, it will default to the minimum PoE power specification (PoE+ Type 2 Class 4). It is recommended to set this to the PoE power specification of the PoE adapter powering the NPA70DA
- Front Panel Lights - enable or disable the front panel LED lights, or set them to time out after a specific time (15, 30 or 60 seconds)
- Serial Baud Rate - specify the baud rate of the serial RS-232 port on the device
- Auto Standby Time (minutes) - specify the time in minutes where the unit will enter standby mode if no audio signal is being received on the selected input (default is 10 minutes)
- Firmware Update - allows a user to update the firmware of the device
- Factory Reset (Excludes Network Settings) - factory defaults all settings except for network configuration
- Factory Reset (Includes Network Settings) - factory defaults all settings including network configuration
- Reboot - power cycles the unit without changing any configuration settings

**Information Page:**

The Information page provides useful information such as firmware version and network settings.

The screenshot shows the 'Information' page of the BLUSTREAM interface. At the top left is the BLUSTREAM logo. To its right is the title 'Information'. Below the logo is a navigation menu with icons and labels: Control, Users, Settings, System, Information (highlighted), Update Password, and Log Out. On the far right is a 'Power' button with a power icon. The main content area is titled 'Status' and contains a table of system and network information.

Status	
Model	NPA70DA
MCU Version	V1.0.0h
GUI Version	V1.0.0e
Hostname	NPA70DA
IP Address	169.254.0.202
Subnet Mask	255.255.255.0
Gateway	192.168.0.1
MAC Address	34:D0:B8:26:29:0E

# Schematic

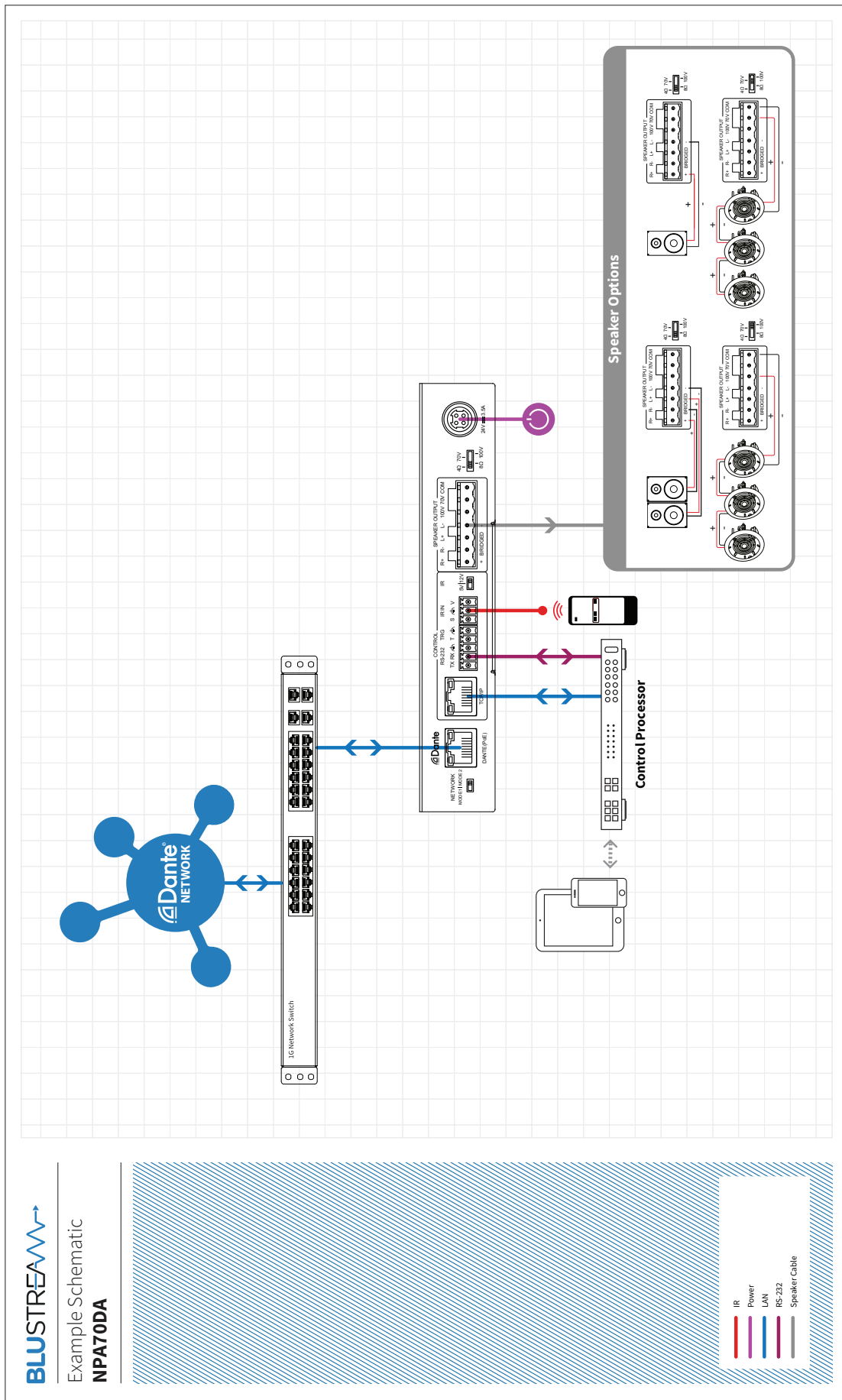

BLUSTREAM

Example Schematic  
NPA70DA

- IR
- Power
- LAN
- RS-232
- Speaker Cable

## Telnet & RS-232 Control Port

The NPA70DA can be controlled via a 3-pin Phoenix to serial RS-232 cable or via Telnet.

The RS-232 communication settings and commands are as follows:

Baud Rate: 57600 bps

Parity: None

Flow Control: None

Data Bit: 8-bit

Stop Bit: 1-bit

RS-232 / TELNET COMMAND	DESCRIPTION
?/HELP	Print Help Information
STATUS	Print System Status And Port Status
PON	Power On, System Run On Normal State
POFF	Power Off, System Run On Power Save State
PWLED FOLLOW ON/OFF	ON: Set System Power Led Follow LCD Status OFF: Set System Power Led Not Follow LCD Status In Power On State,Power Led Always On
RESET	"Reset System Settings To Default (Should Type ""Yes"" To Confirm, ""No"" To Discard)"
RESET ALL	"Reset System and Network Settings To Default (Should Type ""Yes"" To Confirm, ""No"" To Discard)"
REBOOT	Set System Reboot
AUTO STB xx	Set System Auto Standby Time xx=0:Auto Standby Off xx=[1...120]:Auto Standby Time,(mins)
AMPMODE xxx	Set Amp Power to xxx xxx=2:PoE++ Type 4 Class 8 (71W) xxx=3:PoE++ Type 4 Class 7 (62W) xxx=4:PoE++ Type 3 Class 6 (51W) xxx=5:PoE++ Type 3 Class 5 (40W) xxx=6:PoE+ Type 2 Class 4 (25.5W)
KEY ON/OFF	Set System KEY Control On Or Off
LCD ON/OFF/15/30/60	Set LCD Always On Or Auto Turn Off In Power On State Or Turn On 15s/30s/60s
IDLED ON/OFF/15/30/60	Set IDLED On Or Auto Turn Off In 15/30/60s In Power On State Or Turn On 15s/30s/60s
IR ON/OFF	Set System IR Control On Or Off
TRIG ON/OFF	Set Trigger On Or Off
RSB xx	Set RS232 Baud Rate to xx bps xx=[1...6]:1:4800,2:9600,3:19200, 4:38400,5:57600,6:115200
IN VOL yy	Set Input Volume to yy yy=[0...100]:Volume Value
IN VOL+	Increase Input Volume
IN VOL-	Decrease Input Volume
IN xx MUTE ON/OFF	Set Input Mute On Or Off
OUT VOL yy	Set Output Volume to yy yy=[0...100]:Volume Value
OUT VOL+	Increase Output Volume
OUT VOL-	Decrease Output Volume
OUT MUTE ON/OFF	Set Output Mute On Or Off

RS-232 / TELNET COMMAND	DESCRIPTION
OUT DLYT yy	Set Output Delay Time to yy(ms) yy=[1..50]:Delay Time, Millisecond
OUT REVB ON/OFF	Set Output Reverb On Or Off
OUT PHASE yy INV ON/OFF	Set Output L-Inverter Or R-Inverter On Or Off yy=[0,1]0:LEFT,1:RIGHT
OUT MIX yy	Set Output Mix yy yy=[1,2]:1:STEREO,2:LEFT-CH yy=[3,4]:3:RIGHT-CH,4:LEFT-CH and RIGHT-CH
OUT EQ yy VAL zz	Set Output GEQ:yy to zz yy=[1..31]:EQ Index zz=[-10..3]:EQ Value
OUT EQ PRESET yy	Set Output GEQ:yy to Preset:yy yy=[1...3]:1:Flat,2:Custom1,3:Custom2
NET DHCP ON/OFF	Set Auto IP(DHCP) On Or Off
NET IP xxx.xxx.xxx.xxx	Set IP Address
NET GW xxx.xxx.xxx.xxx	Set Gateway Address
NET SM xxx.xxx.xxx.xxx	Set Subnet Mask Address
NET TCPPORT xxxx	Set TCP/IP Port
NET TN xxxx	Set Telnet Port
NET RB	Network Reboot and Apply New Config!!!
NET DNS xxxx	Set DNS Domain Name To xxxx



# Specifications

## NPA70DA

- **Audio Inputs:** 1 x RJ45 Dante® Audio connection
- **Audio Outputs:** 1 x 4-Pin Phoenix connector (4 / 8 ohm speaker)  
1 x 3-Pin Phoenix connector (70 / 100V speaker)
- **Ethernet Port:** 1 x LAN RJ45 connector (Dante®)  
1 x LAN RJ45 connector (Network)
- **RS-232 Serial Port:** 1 x 3-Pin Phoenix connector
- **IR Input Ports:** 1 x 3-Pin Phoenix connector
- **Trigger Input:** 1 x 2-Pin Phoenix connector
- **Rack Mountable:** 19" Rack mounting and wall / surface mount kit included
- **Casing Dimensions (W x H x D):** 202mm x 175mm x 31mm
- **Dimensions Including Connections (W x H x D):** 245mm x 175mm x 31mm
- **Shipping Weight:** 1.8kg
- **Operating Temperature:** 32°F to 104°F (0°C to +40°C)
- **Storage Temperature:** -4°F to 140°F (-20°C to +60°C)
- **Power Supply:** PoE++ Type 4, or 24V/3.5A DC 4-pin DIN

**NOTE:** Specifications are subject to change without notice. Weights and dimensions are approximate.

## AMP POWER SPECIFICATION

POWER SOURCE	AMP OUTPUT
24V/3.5A DC	70W
PoE++ Type 4 Class 8	50W
PoE++ Type 4 Class 7	40W
PoE++ Type 3 Class 6	30W
PoE++ Type 3 Class 5	20W
PoE+ Type 2 Class 4	7.5W

# Package Contents

## NPA70DA

- 1 x NPA70DA
- 1 x 24V/3.5A power supply
- 1 x Remote control
- 1 x IR Receiver
- 1 x Rack mounting kit
- 1 x Wall / surface mounting kit
- 4 x Rubber feet
- 1 x User Manual

# Maintenance

Clean this unit with a soft, dry cloth. Never use alcohol, paint thinner or benzene to clean this unit.

## Acknowledgements

Dante® is a registered trademark of Audinate Pty Ltd.

## Certifications

### FCC Notice

This equipment has been tested and found to comply with the limits for a Class B digital device, pursuant to part 15 of the FCC Rules. These limits are designed to provide reasonable protection against harmful interference in a residential installation. This equipment generates, uses, and can radiate radio frequency energy and, if not installed and used in accordance with the instructions, may cause harmful interference to radio communications. However, there is no guarantee that interference will not occur in a particular installation. If this equipment does cause harmful interference to radio or television reception, which can be determined by turning the equipment off and on, the user is encouraged to try to correct the interference by one or more of the following measures:

- Reorient or relocate the receiving antenna.
- Increase the separation between the equipment and receiver.
- Connect the equipment into an outlet on a circuit different from that to which the receiver is connected.
- Consult the dealer or an experienced radio/TV technician for help.

**CAUTION** - changes or modifications not expressly approved by the party responsible for compliance could void the user's authority to operate the equipment.

### CANADA, INDUSTRY CANADA (IC) NOTICES

This Class B digital apparatus complies with Canadian ICES-003.

Operation is subject to the following two conditions: (1) this device may not cause interference, and (2) this device must accept any interference, including interference that may cause undesired operation of the device.

### CANADA, AVIS D'INDUSTRY CANADA (IC)

Cet appareil numérique de classe B est conforme aux normes canadiennes ICES-003.

Son fonctionnement est soumis aux deux conditions suivantes : (1) cet appareil ne doit pas causer d'interférence et (2) cet appareil doit accepter toute interférence, notamment les interférences qui peuvent affecter son fonctionnement.

### CORRECT DISPOSAL OF THIS PRODUCT

This marking indicates that this product should not be disposed with other household wastes. To prevent possible harm to the environment or human health from uncontrolled waste disposal, recycle it responsibly to promote the sustainable reuse of material resources. To return your used device, please use the return and collection systems or contact the retailer where the product was purchased. They can take this product for environmentally safe recycling.





[www.blustream.com.au](http://www.blustream.com.au)

[www.blustream-us.com](http://www.blustream-us.com)

[www.blustream.co.uk](http://www.blustream.co.uk)